



TUŠ KABINE

SHOWER ENCLOSURES



05

Tuš kabine
Shower enclosures
Tuš kabine
Tuš kabine

Dinamika tuš kabine

Za tuš kabino se odločamo zaradi hitrega tempa življenja, pomanjkanja prostora, manjše porabe vode in manjšega odtisa na okolje. Tuš kabine Kolpasan nam pomagajo kopalnico prostorsko čimbolje izkoristiti, optično povečati, pa tudi vsakodnevno lažje čistiti.

Z izbiro pravega modela in stekla vizualno razpre še tako majhen prostor, da se ne počutimo utesnjeno, ampak varno in sproščeno.

Dynamics of shower enclosure

We opt for a shower enclosure due to the fast pace of life, lack of space, lower water consumption and lower footprint on the environment. Kolpasan shower enclosures help us make the most of the bathroom, optically enlarge it, and facilitate daily cleaning. By choosing the right model and glass, even the tiniest of spaces will be visually enlarged so we won't feel cramped, but safe and relaxed.

Dinamika tuš kabine

Za tuš kabinu se odločujemo zbog brzog tempa života, manjka prostora, manje potrošnje vode i manjeg utjecaja na okoliš. Tuš kabine Kolpasan pomažu nam da što bolje iskoristimo svoju kupaonice, optički je povećamo i olakšamo svakodnevno čišćenje.

Odabir pravog modela i stakla vizualno proširuje čak i mali prostor, kako se ne bi osjećali skučeno, već sigurno i opušteno.

Dinamika tuš kabine

Za tuš-kabinu se odločujemo zbog brzog tempa života, nedovoljno prostora, manje potrošnje vode i manjeg uticaja na okolinu. Tuš-kabine Kolpasan nam pomažu da što bolje iskoristimo svoje kupatilo, da ga optički povećamo i olakšamo svakodnevno čišćenje.

Odabir pravog modela i stakla vizuelno proširuje čak i mali prostor, da se ne osećamo skučeno, već sigurno i opušteno.



5
let garancije
years warranty

3
leta garancije
years warranty

*



* SQ line, Eco Quat



05

132

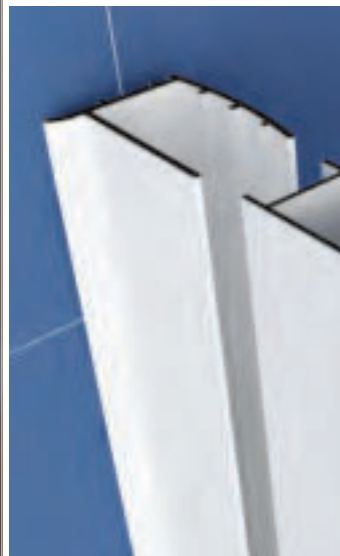
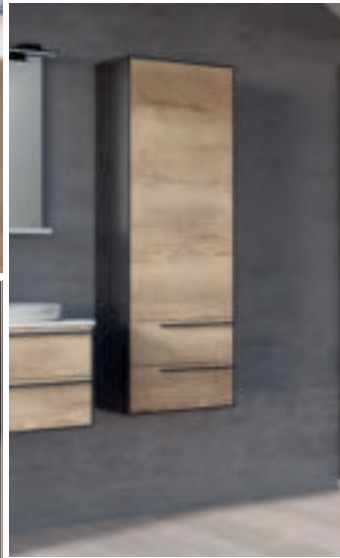
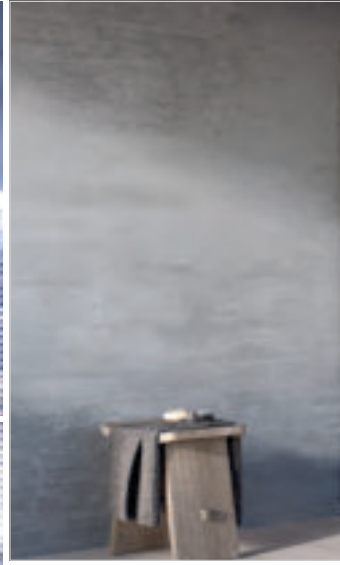
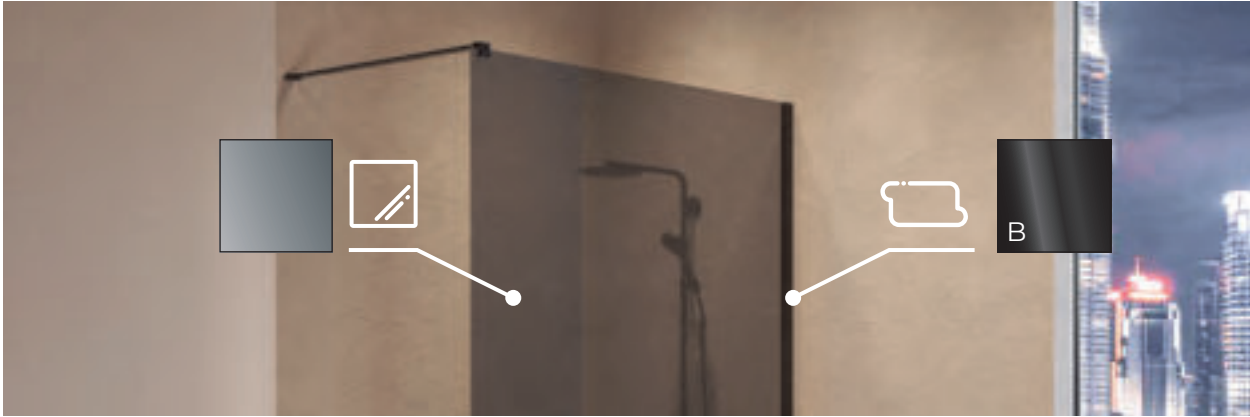

Info



TUŠ KABINE SHOWER ENCLOSURES TUŠ KABINE TUŠ KABINE



- možnosti izbire med različnimi vrstami stekel in profilov
- choose between different types of glass and profiles
- možnost izbora između različnih vrsta stakla i profila
- mogućnost odabira između različnih vrsta stakla i profila



- sodobno oblikovane tuš kabine čistih geometrijskih oblik z robustno konstrukcijo
- contemporary designed shower enclosures of pure geometric shapes
- moderno dizajnirane tuš kabine čistih geometrijskih oblika s robustno konstrukcijo
- moderan dizajn tuš-kabine sa čistim geometrijskim oblikom i čvrstom konstrukcijom



- naši izdelki omogočajo **4** različne možnosti vgradnje
- our products allow **4** different installation options
- naši proizvodi omogočajo **4** različite možnosti ugradnje
- naši proizvodi omogočavaju **4** različite mogućnosti postavljanja

100

- več kot **100** modelov tuš kabin za opremo najrazličnejših vrst kopalnic
- more than **100** models of shower enclosures for the equipment of a wide range of bathrooms
- više od **100** modela tuš kabina za opremo raznih vrsta kupaoonica
- više od **100** modela tuš kada za opremo različnih vrsta kupatila



- možnost prilagajanja oblike pri določenih modelih
- possibility of adjusting the shape of certain models
- možnost podešavanja oblika određenih modela
- mogućnost prilagođavanja oblika određenih modela



- možnost izvedbo nestandardni dimenzij z dodatnimi kompenzacijskimi profili
- possibility of implementing non-standard dimensions with additional compensation profiles
- mogućnost izvedbe nestandardnih dimenzija s dodatnim kompenzacijskim profilima
- mogućnost izvođenja nestandardnih dimenzija sa dodatnim kompenzacionim profilima



Družine tuš kabin in njihove značilnosti

A range of shower enclosures and their characteristics

Skupine tuš-kabina i njihove karakteristike

Skupine tuš-kabina i njihove karakteristike



Polaris

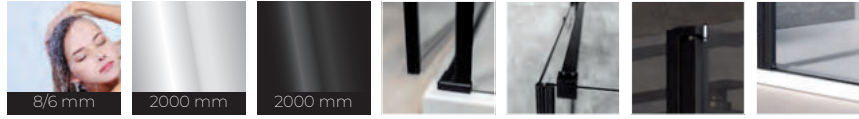

> 140



Polaris fold

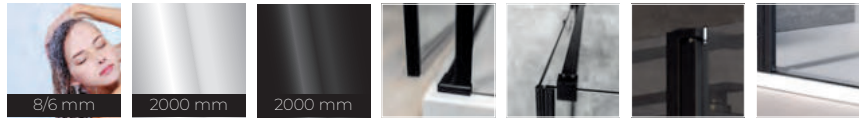

> 146



Andromeda

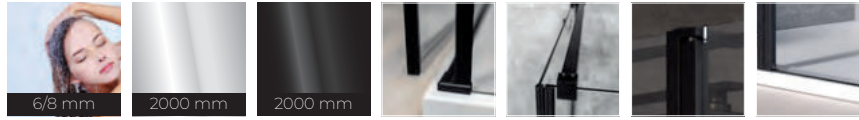

> 152



Atlas

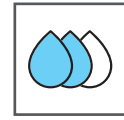

> 160

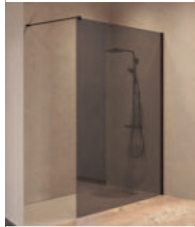

Calypso

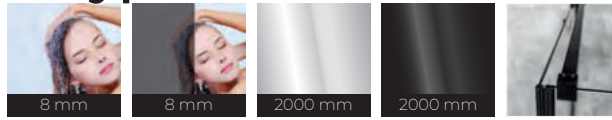

> 168



Virgo UNI

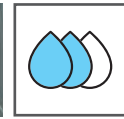

> 172

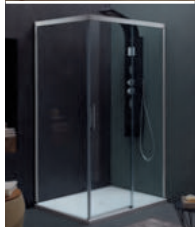

Montes



> 176



Dorsa UNI



> 180



Družine tuš kabin in njihove značilnosti

A range of shower enclosures and their characteristics

Skupine tuš-kabina i njihove karakteristike

Skupine tuš-kabina i njihove karakteristike

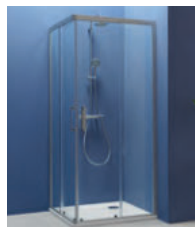

Pulsar

> 184



SQ line

> 192



Luna

> 204

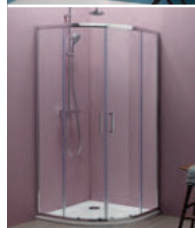
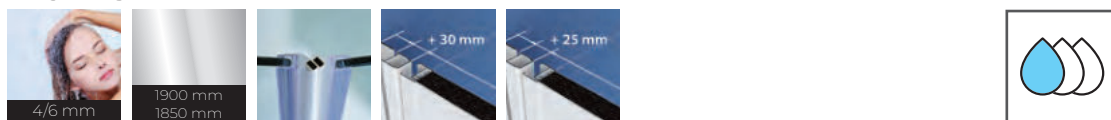

Eco Quat

> 212



Polaris

> 216



Andromeda

> 220



Sole

> 224



Quat

> 228





Tuš kabine - preglednica po oblikah in postavitvah

Shower enclosures - shapes and sizes

Tuš kabine - pregled po oblicima i dimenzijama

Tuš kabine - tabela po oblicima i postavljanjima

program range program program											
Andromeda	Q	D+W	D+W			N	N				
Polaris	Q	D+W	R			N					
Polaris Fold	Q	D+W				N					
Calypso	WIN	WO									
Atlas	TKK	TKP	TV/S+TSv			TV/S	TV/S				
Virgo UNI	TK					TV2D/S					
Montes	TK					TV2D/S					
Dorsa	TK					TV2D/S					
Pulsar	TKK	TKP	TV2D/S+TS			TV2D/S			TKK+TS	TKP+TS	
SQ line	TKK	TKP	TV2D/S+TS	TV4D/S+TS	TKP DIXIE	TV2D/S	TV4D/S		TV2D/S+2TS		
Luna	TV3D/S+TSv3D	TVZ/S+TSvZ				TV3D/S	TVZ/S	TVZ/S			
Eco Quat	TKK	TKP									
Sole											
Quat											

Info

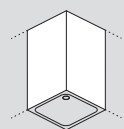

kotna postavitve
corner
kutno postavljanje
ugaono postavljanje

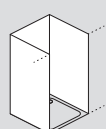



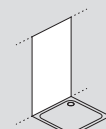



postavitve v niši
recessed
postavljanje u niši
postavljanje u niši

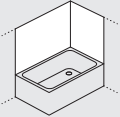

postavitve ob steni
wall
postavljanje uz zid
postavljanje uz zid



program range program program										
Andromeda	 BS 120	 BS 80								
Polaris	 BS 80									
Polaris Fold										
Calypso										
Atlas										
Virgo UNI										
Montes										
Dorsa										
Pulsar										
SQ line										
Luna										
Eco Quat										
Sole	 TP 104 UNI	 TP 102 UNI								
Quat	 TP 80 UNI									

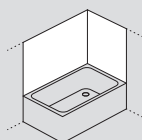

kotna postavitvev
 corner
 kutno postavljanje
 ugaono postavljanje



Faktorji vodotesnosti tuš kabin po modelih

Factors affecting water tightness of shower cabins according to models

Čimbenici vodonepropusnosti tuš kabina po modelima

Faktori zaptivanja tuš kabina po modelima



Kljub tesnilom na tuš kabini voda še vedno izteka. Je to normalno?
Despite the sealants on my shower enclosure, the water still leaks. Is this normal?
Unatoč brtvilima na tuš kabini voda još uvijek otječe. Je li normalno?
Bez obzira na zaptivke na tuš kabini voda i dalje curi. Da li je to normalno?

Tuš kabine ponujajo različne stopnje vodotesnosti, vendar popolne zaščite proti uhajanju vode ni mogoče zagotoviti.

Shower enclosures come in various levels of water resistance. However, nobody can ensure total protection against water leakage.

Tuš kabine nude različite stupnjeve brtvljenja, ali potpunu zaščito od otjecanja vode nije moguće osigurati.

Tuš kabine nude različite nivoe zaptivanja, ali se potpuna zaštita od curenja vode ne može obezbediti.

F 1

Faktor 1

Modeli tuš kabin v izvedbi z aluminijastim okvirjem

Ti modeli omogočajo posebno dobre vodotesne lastnosti. Priporočajo se za prhanja z večjo frekvenco in uporabo masažnih prh z veliko količino vode.

Faktor 1

Shower cabin models featuring an aluminium frame

These models feature particularly good water tightness characteristics and are recommended for more frequent showers and use of massage showers consuming large quantities of water.

Čimbenik 1

Modeli tuš kabina u izvedbi s aluminijemskim okvirom

Ti modeli omogućuju posebno dobra vodonepropusna svojstva. Preporučuju se za tuširanja s većom frekvencijom i uporabom masažnih tuševa s velikom količinom vode.

Faktor 1

Modeli tuš kabina u izvedbi sa aluminijumskim okvirom

Ti modeli omogućavaju posebno dobre osobine u pogledu zaptivanja. Preporučuju se za tuširanja sa većom frekvencijom i korišćenje masažnih tuševa sa velikom količinom vode.

Kabine s spodnjim okvirjem
Cabins with the bottom frame
Kabine s donjim okvirom
Kabine sa donjim okvirom



F 1

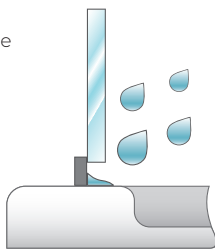

F 2

Faktor 2

Modeli tuš kabin z dodatnim zaščitnim profilom

Dodatno nameščen profil izboljšuje stopnjo zaščite vodotesnosti, vendar je ne more 100% zagotoviti.

Faktor 2

Shower cabin models with an additional protection profile

Additionally installed profile improves the water tightness protection level, but it cannot guarantee it 100%.

Čimbenik 2

Modeli tuš kabina s dodatnim zaštitnim profilom

Dodatno postavljen profil poboljšava stupanj zaštite vodonepropusnosti, ali ju ne može 100% osigurati.

Faktor 2

Modeli tuš kabina sa dodatnim zaštitnim profilom

Dodatno montiran profil poboljšava stepen zaštite u pogledu zaptivanja, ali ga ne može garantovati 100%.

Dodatni zaščitni profil
Additional protection profiles
Dodatni zaštitni profil
Dodatni zaštitni profil



F 2



F 3

Faktor 3

Modeli tuš kabin v izvedbi brez aluminijastega okvirja

Imajo zadovoljivo stopnjo zaščite vodotesnosti. Zaradi manjkajočega spodnjega okvirja, ima voda možnost lažjega iztekanja. Kljub temu so ti modeli kabin elegantni, ekskluzivni in omogočajo lažje čiščenje.

Faktor 3

Shower cabin models without an aluminium frame

They provide a satisfactory water tightness protection level. Since the bottom frame is missing, water can more easily leak out. Nevertheless, these cabin models are elegant, exclusive and are easier to clean.

Čimbenik 3

Modeli tuš kabina u izvedbi bez aluminijemskog okvira

Imaju zadovoljavajući stupanj zaštite u smislu vodonepropusnosti. Zbog manjkajućega donjeg okvira voda ima mogućnost lakšega istjecanja. Unatoč tomu ti su modeli kabina elegantni, ekskluzivni i omogućuju lakše čišćenje.

Faktor 3

Modeli tuš kabina u izvedbi bez aluminijumskog okvira

Imaju zadovoljavajući stepen zaštite u pogledu zaptivanja. Zbog nepostojećeg donjeg okvira, voda ima mogućnost lakšeg oticanja. Bez obzira na to, ti modeli kabina su elegantni, ekskluzivni i omogućavaju lakše čišćenje.

Kabine bez okvirja
Cabins without a frame
Dodatni zaštitni profil
Kabine bez okvira



F 3



Design tuš zaslonov odreja stopnjo vodotesnosti. Osnovno pravilo je: čim večji in višji je spodnji profil, toliko je višja stopnja zaščite.

The design of the shower screens determines the water tightness. The basic rule: the larger and taller the middle profile, the higher the protection level.

Dizajni tuš zaslona određuju stupanj vodonepropusnosti. Osnovno je pravilo: što je veći i viši donji profil, toliko je viši stupanj zaštite.

Dizajn tuš paravana određuje stepen zaptivanja. Osnovno pravilo je: što je viši i veći donji profil, veći je i stepen zaštite.



Pogosta vprašanja - masažne in tuš kabine

FAQ - Massage and Shower Enclosures

Učestala pitanja - masažne i tuš kabine

Česta pitanja - masažne i tuš kabine



Katere prednosti prinaša zaščita stekel Clean Coat pri tuš kabinah?

What are the advantages of Clean Coat-protected glass for shower enclosures?

Koje prednosti donosi zaštita stakal Clean Coat a kod tuš kabina?

Koje prednosti donosi zaštita stakala Clean Coat kod tuš kabina?

kolpa Clean Coat

Prednosti zaščite stekel tuš kabin:

- **estetske:** čist in svetleč izgled, ki traja dlje časa. Zaradi odpornosti proti umazaniji, madežem in potemnenju, se podaljša prvotni videz
- **funkcionalne:** omogoča zelo preprosto čiščenje
- **higijske:** omogoča hitrejše splakanje, ki odstrani umazanijo, sol in bakterije in za sabo ne pušča usedlin in ostankov. Če je steklena površina dlje časa izpostavljena vodi, olajša odstranitev usedle umazanije z večkratnim umivanjem.
- **ekološke:** manjša uporaba bolj agresivnih čistil

Advantages of shower enclosure glass-protection:

- **Aesthetics:** clean and shiny appearance that lasts longer; the resistance to dirt, stains and dark blotches prolongs its original appearance.
- **Functionality:** extremely easy to clean
- **Hygienic aspect:** enables faster rinsing, to remove dirt, salt and bacteria, and leaves no deposits and remains. If the glass is exposed to water for a longer period of time, it facilitates removal of deposited dirt through multiple washing.
- **Ecological aspect:** reduces use of more aggressive cleaning agents.



Prednosti zaštite stakala tuš kabina:

- **estetske:** čist i svjetleći izgled koji traje duže vremena. Zbog otpornosti na nečistoće, mrlje i tamnjenje produžuje se prvobitni izgled
- **funkcionalne:** omogućava vrlo jednostavno čišćenje
- **higijenske:** omogućava brže ispiranje koje uklanja nečistoće, sol i bakterije i za sobom ne ostavlja talog i ostatke. Ako je staklena površina duže vrijeme izložena vodi, olakšava uklanjanje nataložene nečistoće koja je nastala višekratnom uporabom.
- **ekološke:** manja potrošnja agresivnijih sredstava za čišćenje

Prednosti zaštite stakala tuš kabina:

















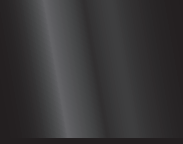

- **estetske:** čist i sjajan izgled koji traje duže vreme. Zbog otpornosti na prljavštinu, fleke i potamnjivanje prvobitni izgled duže traje
- **funkcionalne:** omogućava vrlo jednostavno čišćenje
- **higijenske:** omogućava brže ispiranje koje uklanja prljavštinu, so i bakterije i iza sebe ne ostavlja naslage i ostatke. Ukoliko je staklena površina duže vreme izložena vodi, olakšava uklanjanje naslaga prljavština višekratnim pranjem
- **ekološke:** manja potrošnja agresivnijih sredstava za čišćenje

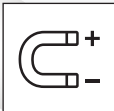

Polariss

POLARIS



 <p>8/6 mm</p>	<p>8/6 mm kaljeno prozorno steklo 8/6 mm transparent tempered glass 8/6 mm kaljeno prozorno staklo 8/6 mm prozirno kaljeno staklo</p>	 
 <p>2000 mm</p>	<p>Silver Brill profili (visokopolirana srebrna galvanska prevleka) Silver Brill Studs (high gloss-polished silver galvanised coating) Silver Brill profili (visokopolirana srebrna galvanska prevlaka) Silver Brill profili (visokopolirani srebrni galvanski premaz)</p>	  <p>SBR</p>
 <p>2000 mm</p>	<p>BLACK (črni) profili, prašno lakiranje BLACK profiles, powder coating BLACK (crni) profili, lakiranje prahom BLACK (crni) profili, suvo lakiranje</p>	  <p>B</p>
	<p>zapiranje z magnetnim profilom magnetic edge closure zatvaranje s magnetskim profilom zatvaranje pomoću magnetnog profila</p>	
	<p>tečaji z dvižno funkcijo hinges with lifting function okovi s podiznim profilom šarke sa funkcijom podizanja</p>	
	<p>opora za stabilnost tuš kabine support for the stability of the shower enclosure potpora za stabilnost tuš kabine oslonac za stabilnost tuš kabine</p>	
	<p> dodatni aluminijasti profil na tuš kadi preprečuje iztekanje vode an additional aluminium edge on the shower tray prevents overflow dodatni aluminijski profil na tuš kadi sprječava istjecanje vode dodatni aluminijumski profil na tuš kadi sprečava izlivanje vode</p>	
	<p>Clean coat, zaščitni premaz Clean coat, protective coating Clean coat, zaštitni premaz Clean coat, zaštitni premaz</p>	

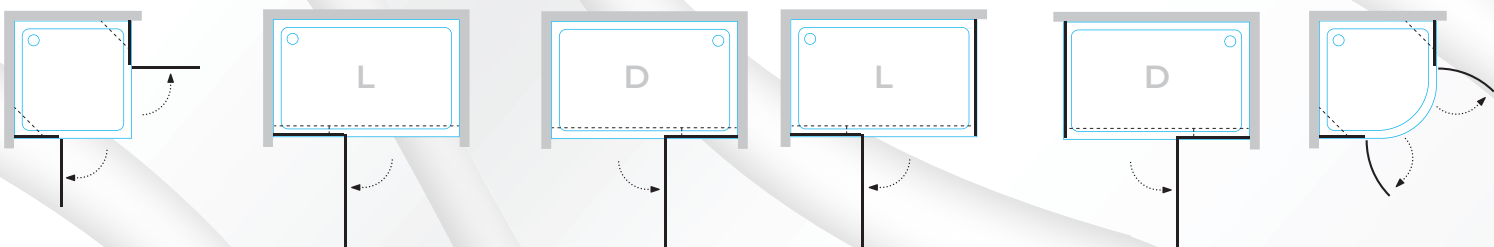

Polaris Q 100, 90, 80

142

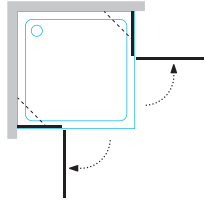

Q 100, 90, 80





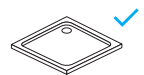
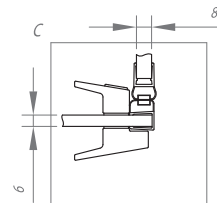
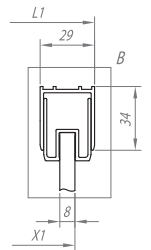
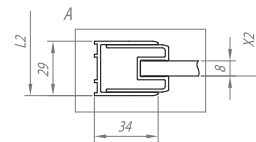
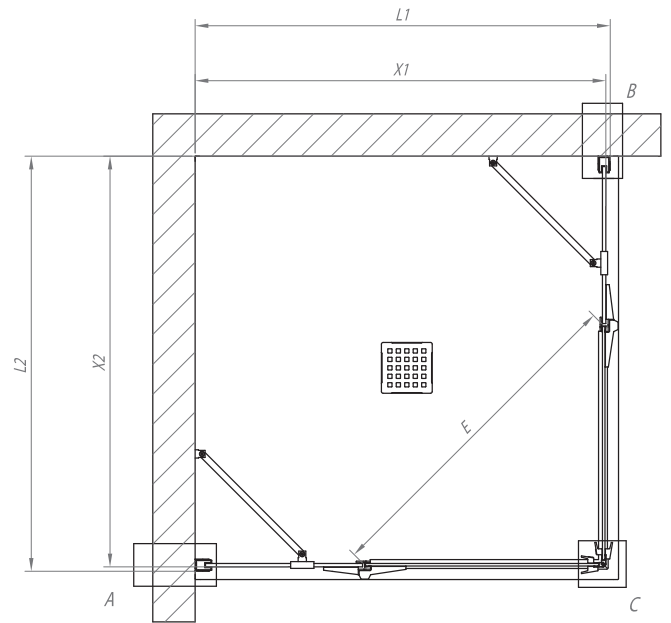

- Kotna tuš kabina z dvema vratnima kriloma na tečajih.
- Corner shower enclosure with double-wing doors.
- Kutna tuš kabina s dva vratna krila na šarkama.
- Četrtasta tuš kabina sa dva vratna krila na šarkama.



-  8/6 mm
-  2000 mm
-  2000 mm
- 
- 



Tello, Lavolta, Lerock zero, Moonwalk, Capo, Pandora Tray, Canary, Serra, Drop, Flamenco, Evelin Tray Q, Trin.

Polaris			L1 	L2 	X1 	X2 		E 	
Q 100			980 - 990	980 - 990	970 - 980	970 - 980	2000	790	
Q 90			880 - 890	880 - 890	870 - 880	870 - 880	2000	790	
Q 80			780 - 790	780 - 790	770 - 780	770 - 780	2000	650	

Polaris Q 100, 90, 80

Polaris N 140, 120, 100, 90 - L,R

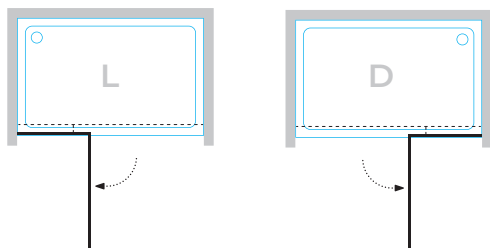

N 140, 120, 100, 90 - L,D

- Samostojna tuš vrata, enostransko odpiranje.
- Self-supporting shower door, single-side opening.
- Samostalna tuš vrata, jednostrano otvaranje.
- Samostoječa tuš vrata, jednostrano otvaranje.

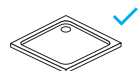
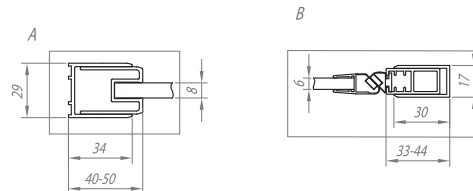
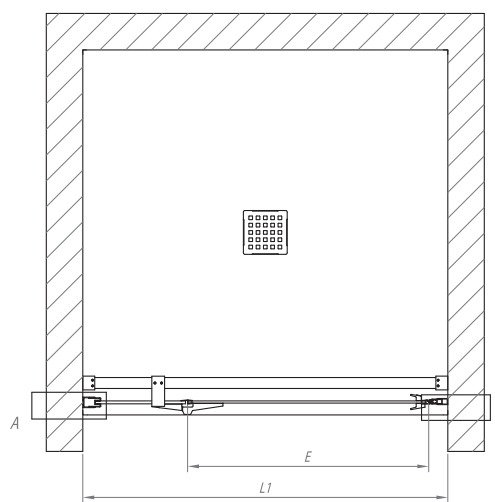

Ballo, Tello, Lavolta, Lerock zero, Ramona tray, Moonwalk, Limbo, Re-walk, Acro, Pandora Tray, Canary, Serra, Drop, Flamenco, Funky, Evelin Tray Q, Trin.

Polaris			L1	L2	X1	X2		E	
N 140			1380 - 1400				2000	630	
N 120			1180 - 1200				2000	630	
N 100			980 - 1000				2000	630	
N 90			880 - 900				2000	530	

Polaris D 140, 120, 100, 90, 80 + W 100, 90, 80

144

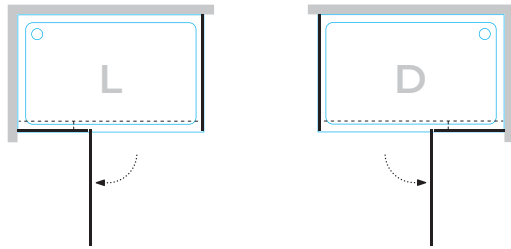

D 140, 120, 100, 90, 80 + W 100, 90, 80

- Tuš vrata s tuš steno.
- Shower door with shower wall.
- Tuš vrata s tuš panelom.
- Tuš vrata sa tuš zidom.

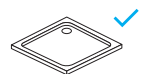
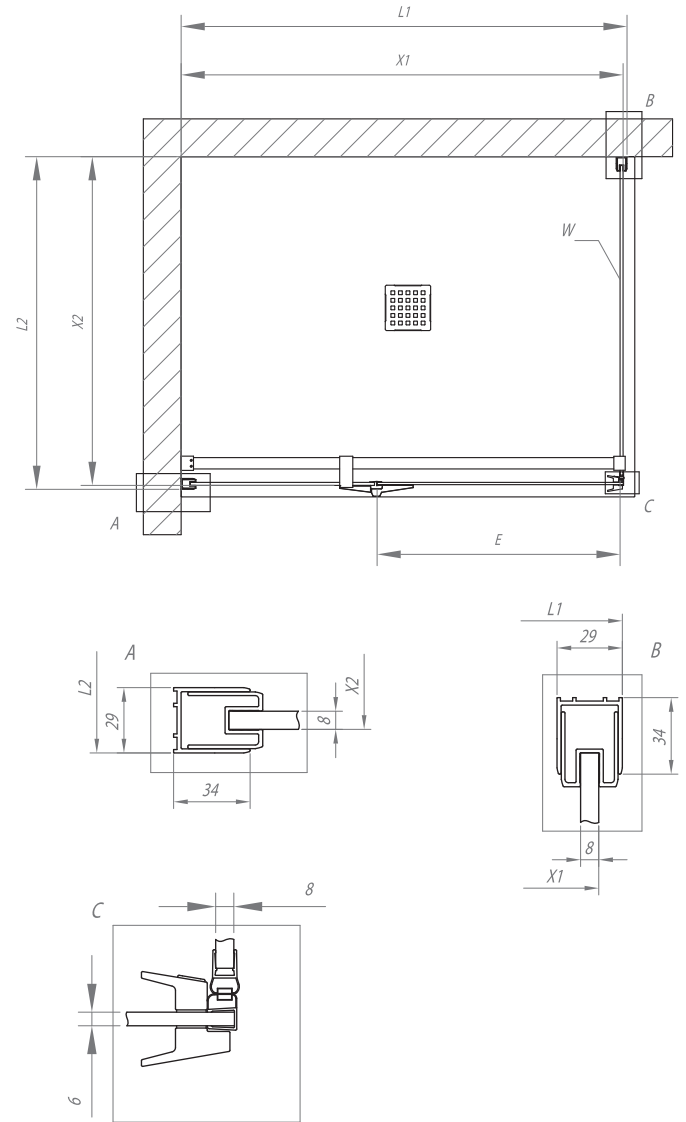
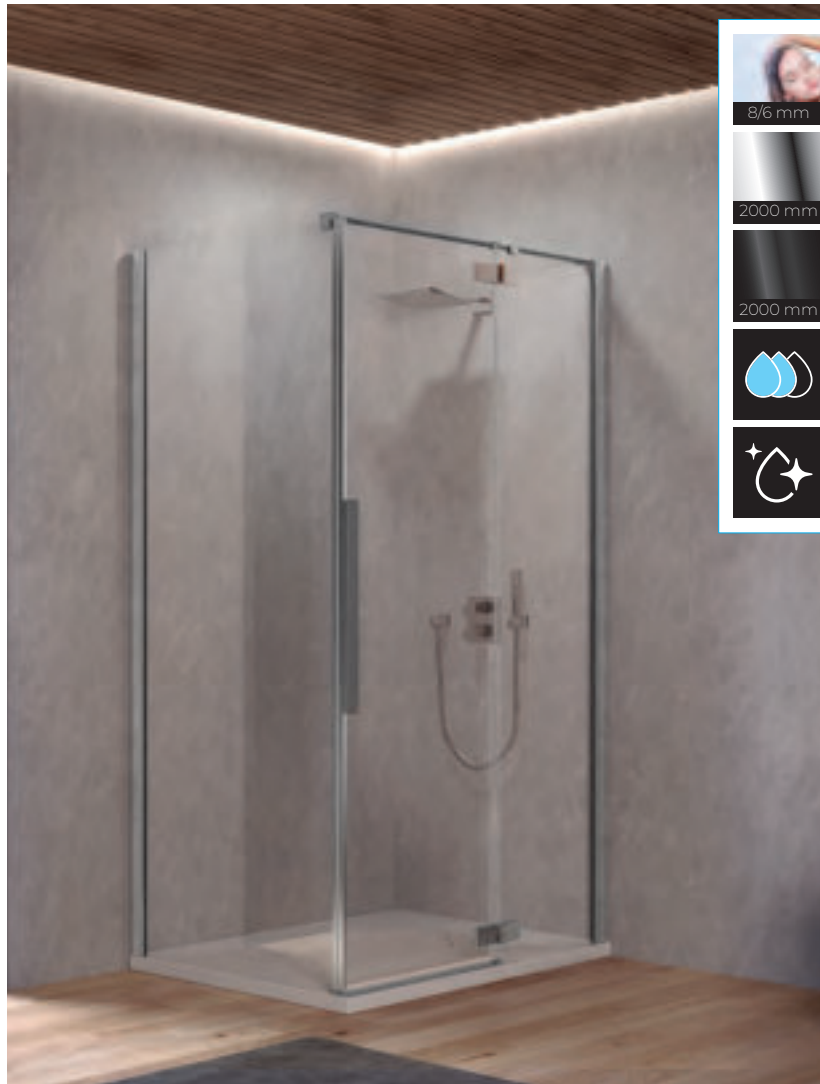

Ballo, Tello, Lavolta, Lerock zero, Ramona tray, Moonwalk, Limbo, Re-walk, Acro, Pandora Tray, Canary, Serra, Drop, Flamenco, Funky, Evelin Tray Q.

Polaris			L1	L2	X1	X2		E	
D 140			1380 - 1390		1370 - 1380		2000	610	
D 120			1180 - 1190		1170 - 1180		2000	610	
D 100			980 - 990		970 - 980		2000	610	
D 90			880 - 890		870 - 880		2000	510	
D 80			780 - 790		770 - 780		2000	450	
W 100				980 - 990		970 - 980	2000		
W 90				880 - 890		870 - 880	2000		
W 80				780 - 790		770 - 780	2000		

Polaris R 100, 90

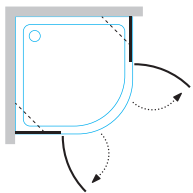

R 100, 90

- Polkrožna tuš kabina z dvema vratnima kriloma na tečajjih.
- Semi-circular shower enclosure with double-wing doors.
- Polukružna tuš kabina s dva vratna krila na šarkama.
- Polukružna tuš kabina sa dva vratna krila na šarkama.

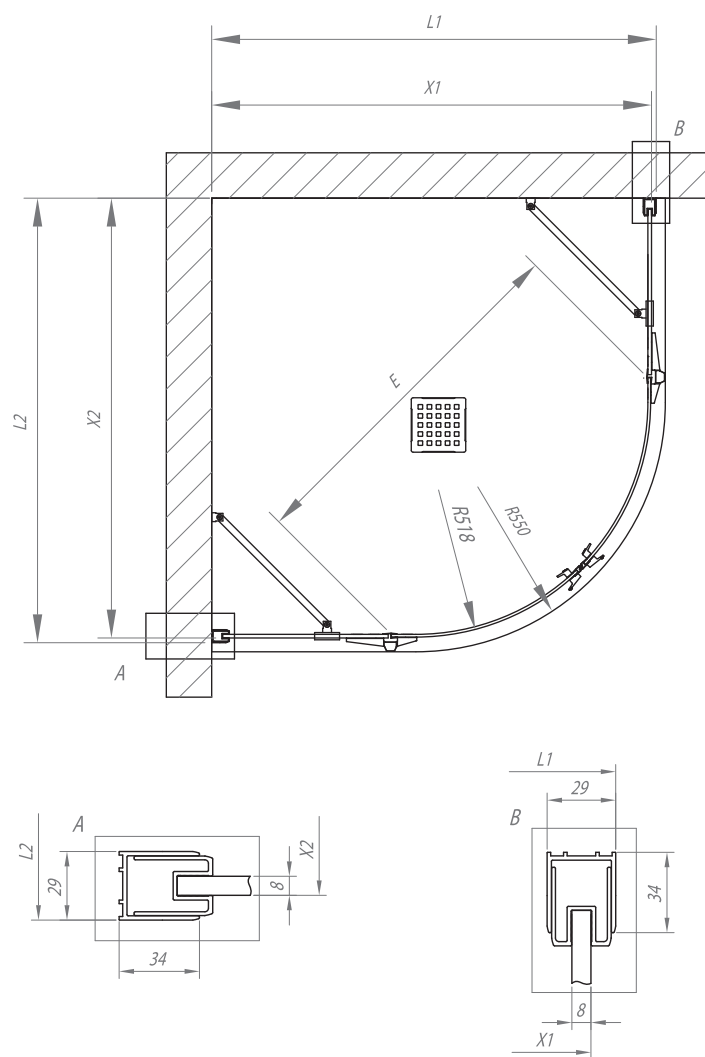
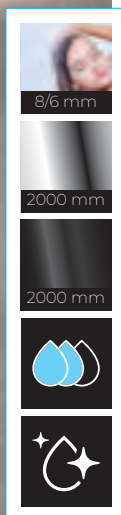

Polaris R 100, 90



Lavolta R, Moonwalk R, Macarena, Drop R, Dixie, Evelin Tray R, Ontex.



















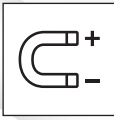

Polaris			L1	L2	X1	X2			E	
R 100			980 - 990	980 - 990	970 - 980	970 - 980	550	2000	775	
R 90			880 - 890	880 - 890	870 - 880	870 - 880	550	2000	775	



Polariss fold

POLARIS FOLD

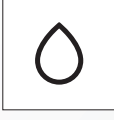

 8/6 mm	<p>8/6 mm kaljeno prozorno steklo 8/6 mm transparent tempered glass 8/6 mm kaljeno prozorno staklo 8/6 mm prozirno kaljeno staklo</p>	 
 2000 mm	<p>Silver Brill profili (visokopolirana srebrna galvanska prevleka) Silver Brill Studs (high gloss-polished silver galvanised coating) Silver Brill profili (visokopolirana srebrna galvanska prevleka) Silver Brill profili (visokopolirani srebrni galvanski premaz)</p>	  SBR
 2000 mm	<p>BLACK (črni) profili, prašno lakiranje BLACK profiles, powder coating BLACK (crni) profili, lakiranje prahom BLACK (crni) profili, suvo lakiranje</p>	  B
 	<p>zapiranje z magnetnim profilom magnetic edge closure zatvaranje s magnetskim profilom zatvaranje pomoću magnetnog profila</p>	
 	<p>obračalni profil z dvizno funkcijo turning section with lifting function okretni profil s podiznom funkcijom okretni profil sa funkcijom podizanja</p>	
 	<p>tečaji z dvizno funkcijo hinges with lifting function okovi s podiznim profilom šarke sa funkcijom podizanja</p>	
 	<p>opora za stabilnost tuš kabine support for the stability of the shower enclosure potpora za stabilnost tuš kabine oslonac za stabilnost tuš kabine</p>	
 	<p>dodatni aluminijasti profil na tuš kadi preprečuje iztekanje vode an additional aluminium edge on the shower tray prevents overflow dodatni aluminijski profil na tuš kadi sprječava istjecanje vode dodatni aluminijumski profil na tuš kadi sprečava izlivanje vode</p>	
 kolpa Clean Coat®	<p>Clean coat, zaščitni premaz Clean coat, protective coating Clean coat, zaštitni premaz Clean coat, zaštitni premaz</p>	

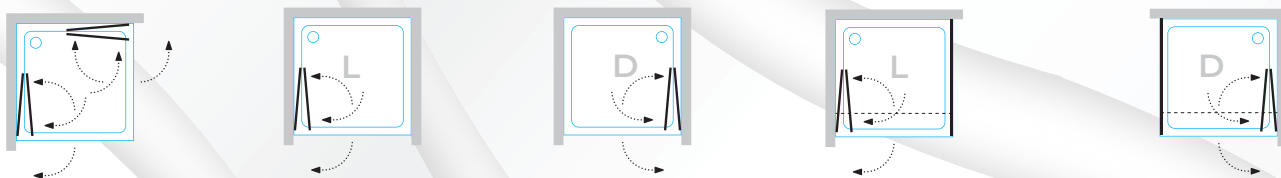

Polaris fold Q 100, 90, 80

148

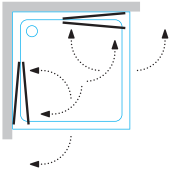

Q 100, 90, 80

- Kotna tuš kabina, zložljiva na notranjo ali zunanjo stran.
- Corner shower cabin, can fold inwards or outwards.
- Kutna tuš kabina, sklopiva na unutarnju i vanjsku stranu.
- Ugaona tuš kabina, sklopiva na unutrašnju ili spoljašnju stranu.

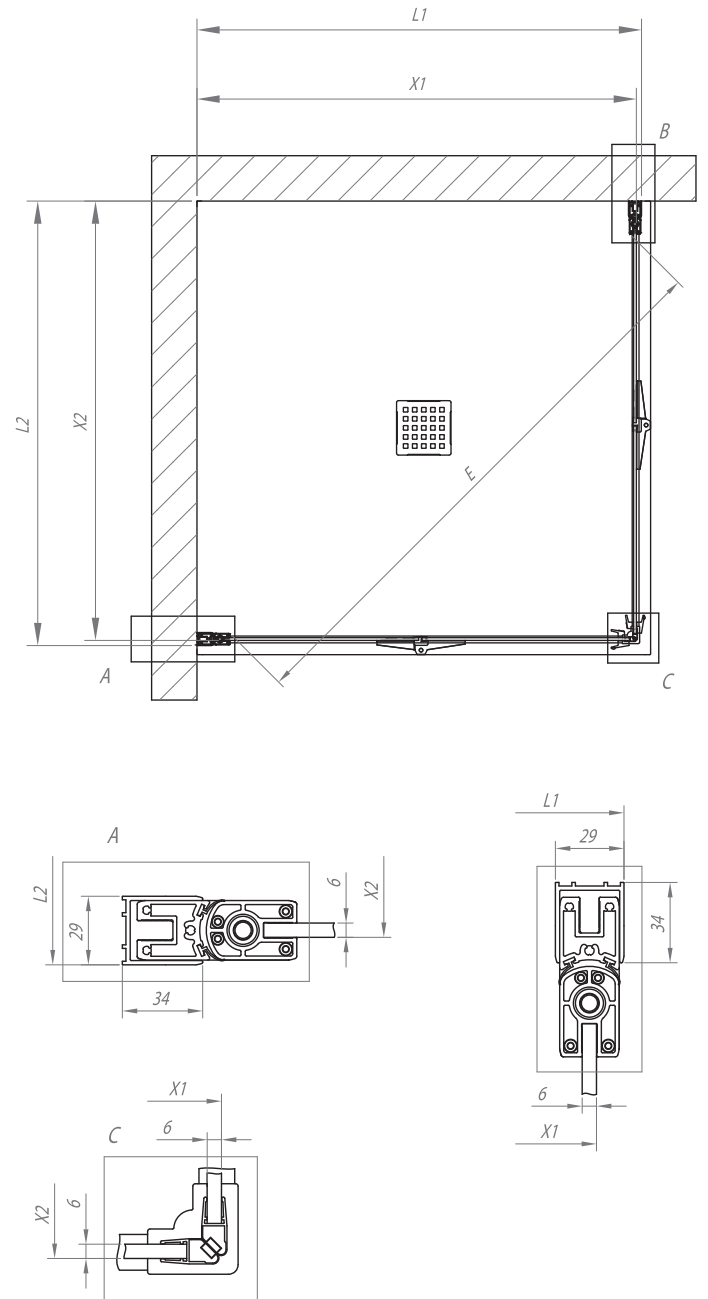
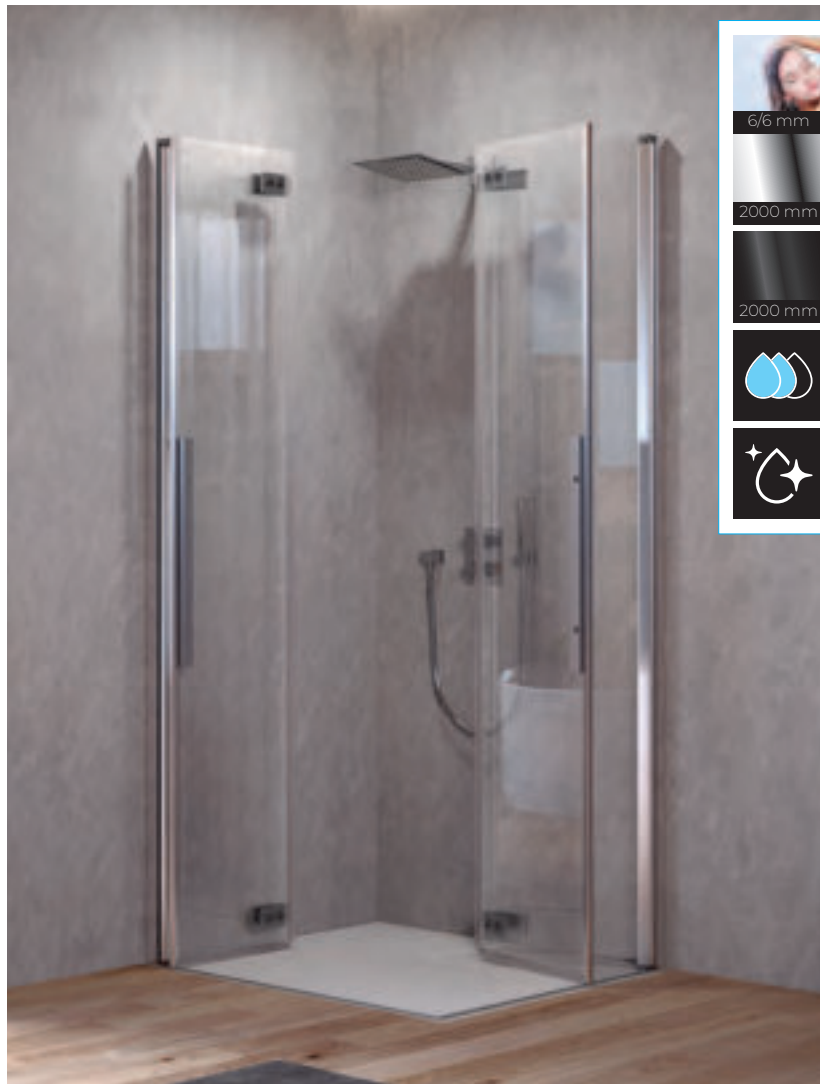

Polaris fold Q 100, 90, 80

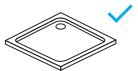

Ballo, Tello, Lavolta, Lerock zero, Ramona tray, Moonwalk, Limbo, Re-walk, Capo, Acro, Pandora Tray, Canary, Serra, Drop, Flamenco, Evelin Tray Q.

Polaris fold			L1	L2	X1	X2		E	
Q 100			980 - 990	980 - 990	969 - 979	969 - 979	2000	1250	
Q 90			880 - 890	880 - 890	869 - 879	869 - 879	2000	1100	
Q 80			780 - 790	780 - 790	769 - 779	769 - 779	2000	970	

Polaris fold N 100, 90, 80



N 100, 90, 80

- Samostojna tuš vrata, zložljiva na notranjo ali zunanjo stran. Možnost montaže v nišo.
- Self-supporting shower door, single-side opening. Installed in a recess.
- Samostoječa tuš vrata, sklopiva na unutrašnju i vanjsku stranu. Mogućnost montaže u nišu.
- Samostojeća tuš vrata, sklopiva na unutrašnju ili spoljašnju stranu. Mogućnost montaže u nišu.

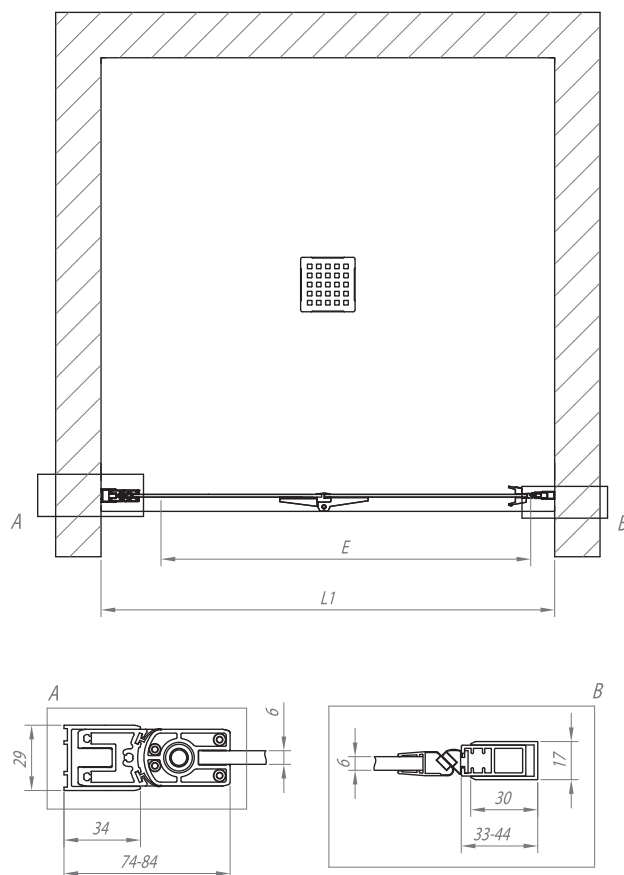

Polaris fold N 100, 90, 80

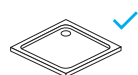

✓ Ballo, Tello, Lavolta, Lerock zero, Ramona tray, Moonwalk, Limbo, Re-walk, Capo, Acro, Pandora Tray, Canary, Serra, Drop, Flamenco, Evelin Tray Q..

Polaris fold			L1	L2	X1	X2		E	
N 100			980 - 1000				2000	815	
N 90			880 - 900				2000	715	
N 80			780 - 800				2000	615	

Polaris fold D 100, 90, 80 + W 100, 90, 80

150



D 100, 90, 80 + W 100, 90, 80

- Tuš kabina - vrata in stena, zložljiva na notranjo ali zunanjo stran.
- Shower enclosure - door and wall, can fold inwards or outwards.
- Tuš kabina - vrata i stijena, sklopiva na unutrašnju i vanjsku stranu.
- Tuš kabina - vrata i zid, sklopiva na unutrašnju ili spoljašnju stranu.

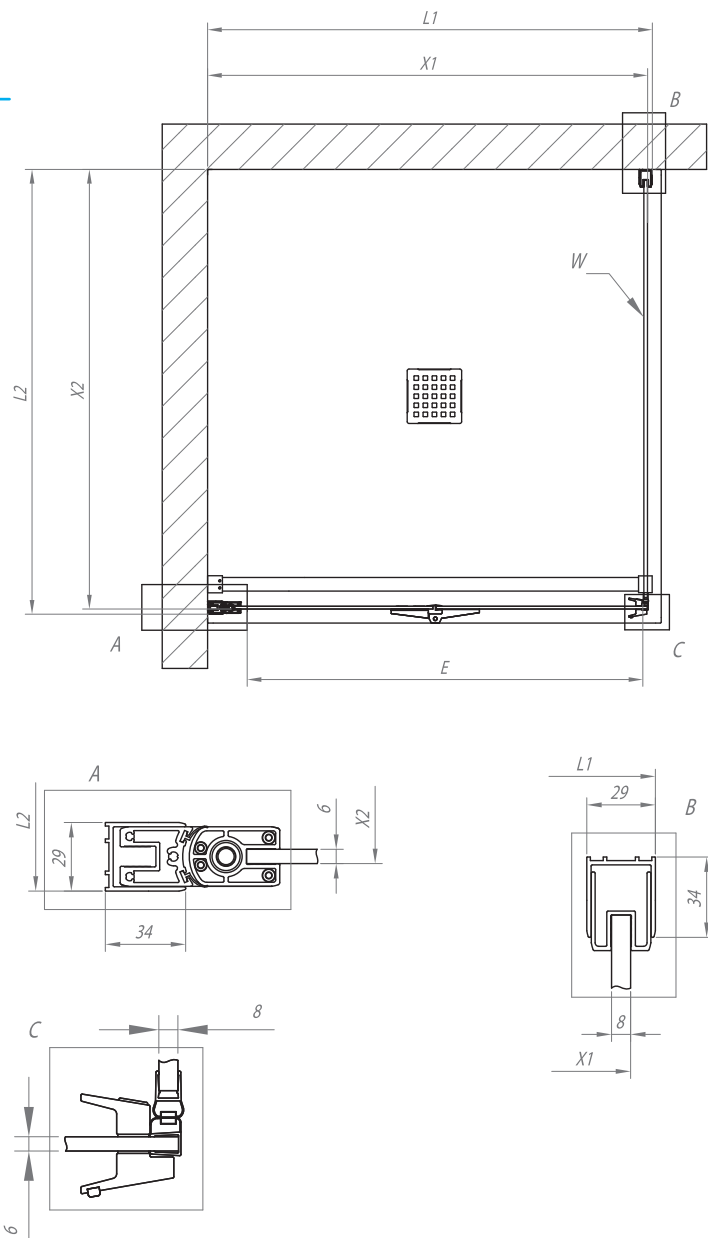

Polaris fold D 100, 90, 80 + W 100, 90, 80

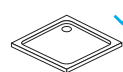

✓ Tello, Lavolta, Lerock zero, Moonwalk, Re-walk, Capo, Acro, Pandora Tray, Canary, Serra, Drop, Flamenco, Funky, Evelin Tray Q.

Polaris fold			L1	L2	X1	X2		E	
W 100			980 - 990	980 - 990		969 - 979	2000		
W 90			880 - 890	880 - 890		869 - 879	2000		
W 80			780 - 790	780 - 790		769 - 779	2000		
D 100			980 - 990		970 - 980		2000	840	
D 90			880 - 890		870 - 880		2000	740	
D 80			780 - 790		770 - 780		2000	640	

















Andromeda

ANDROMEDA



 <p>8/6 mm</p>	<p>8/6 mm kaljeno prozorno steklo 8/6 mm transparent tempered glass 8/6 mm kaljeno prozorno staklo 8/6 mm prozirno kaljeno staklo</p>	 
 <p>2000 mm</p>	<p>Silver Brill profili (visokopolirana srebrna galvanska prevleka) Silver Brill Studs (high gloss-polished silver galvanised coating) Silver Brill profili (visokopolirana srebrna galvanska prevlaka) Silver Brill profili (visokopolirani srebrni galvanski premaz)</p>	  <p>SBR</p>
 <p>2000 mm</p>	<p>BLACK (črni) profili, prašno lakiranje BLACK profiles, powder coating BLACK (crni) profili, lakiranje prahom BLACK (crni) profili, suvo lakiranje</p>	  <p>B</p>
	<p>zapiranje z magnetnim profilom magnetic edge closure zatvaranje s magnetskim profilom zatvaranje pomoću magnetnog profila</p>	
	<p>obračalni profil z dvižno funkcijo turning section with lifting function okretni profil s podiznom funkcijom okretni profil sa funkcijom podizanja</p>	
	<p>opora za stabilnost tuš kabine support for the stability of the shower enclosure potpora za stabilnost tuš kabine oslonac za stabilnost tuš kabine</p>	
	<p> dodatni aluminijasti profil na tuš kadi preprečuje iztekanje vode an additional aluminium edge on the shower tray prevents overflow dodatni aluminijski profil na tuš kadi sprječava istjecanje vode dodatni aluminijumski profil na tuš kadi sprečava izlivanje vode</p>	
	<p>Clean coat, zaščitni premaz Clean coat, protective coating Clean coat, zaštitni premaz Clean coat, zaštitni premaz</p>	

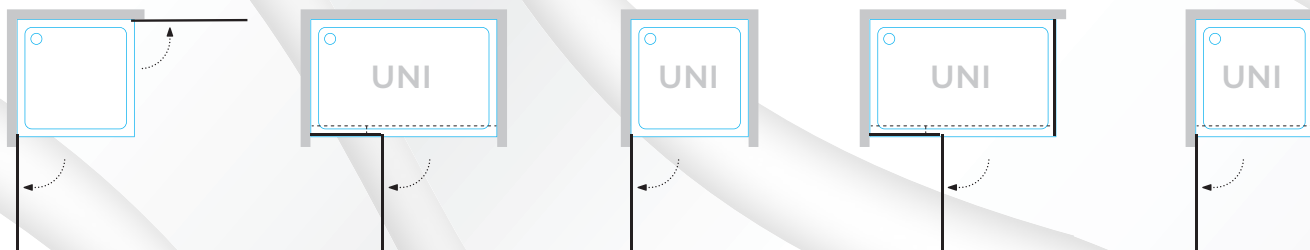

Andromeda Q 100, 90, 80

154

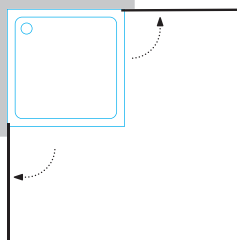

Q 100, 90, 80

- Kotna tuš kabina z dvema vratnima kriloma.
- Corner shower enclosure with double-wing doors.
- Kutna tuš kabina s dva vratna krila.
- Četrtasta tuš kabina sa dva vratna krila.

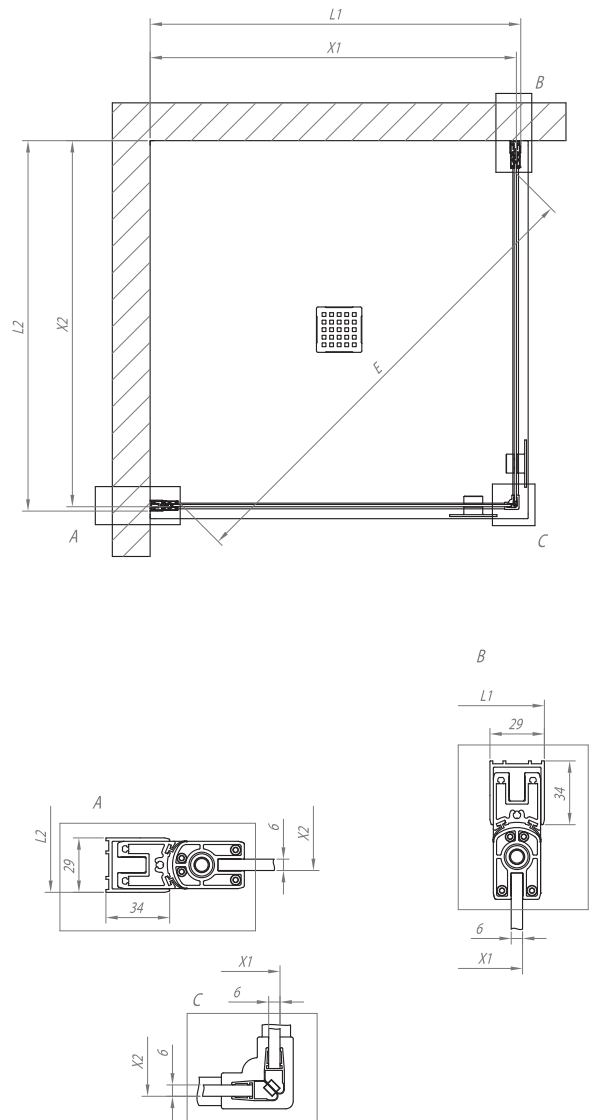

Andromeda Q 100, 90, 80



Tello, Lavolta, Lerock zero, Capo, Pandora Tray, Canary, Serra, Drop, Flamenco, Evelin Tray Q., Trin.

Andromeda			L1	L2	X1	X2		E	
Q 100			980 - 990	980 - 990	969 - 979	969 - 979	2000	1250	
Q 90			880 - 890	880 - 890	869 - 879	869 - 879	2000	1100	
Q 80			780 - 790	780 - 790	769 - 779	769 - 779	2000	970	

Andromeda N 160, 140, 120

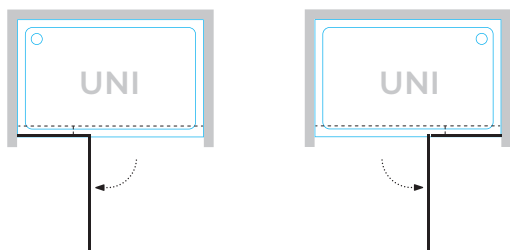

N 160, 140, 120

- Samostojna tuš vrata, enostransko odpiranje.
- Self-supporting shower door, single-side opening.
- Samostalna tuš vrata, jednostrano otvaranje.
- Samostoječa tuš vrata, jednostrano otvaranje.

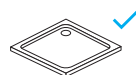
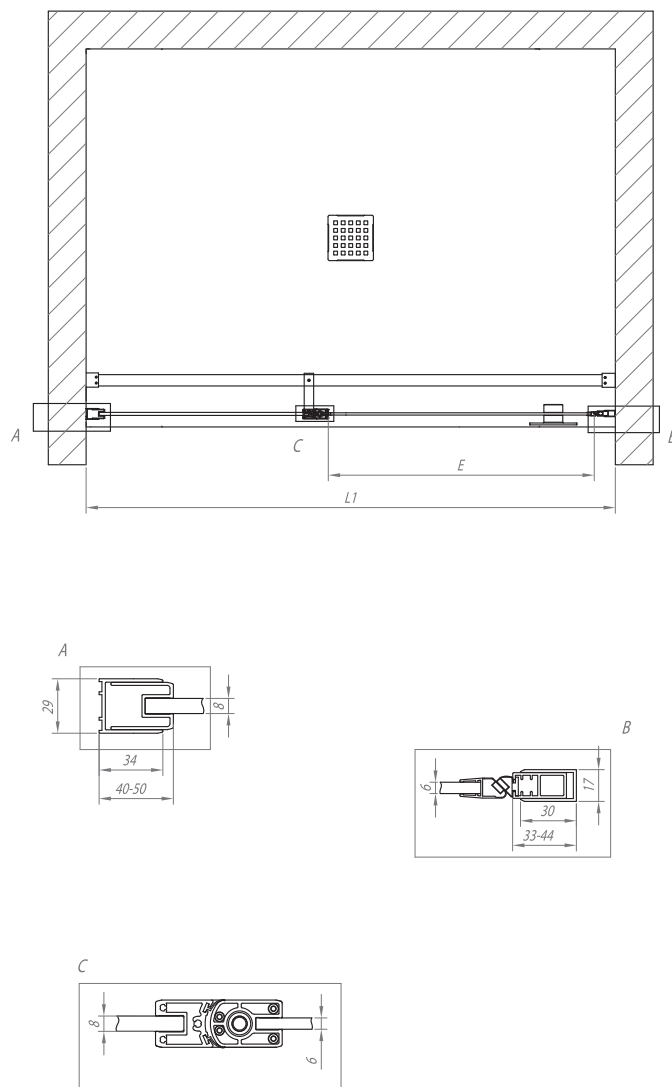

✓ Ballo, Tello, Lavolta, Lerock zero, Ramona tray, Moonwalk, Limbo, Re-walk, Capo, Acro, Pandora Tray, Canary, Serra, Drop, Flamenco, Evelin Tray Q.

Andromeda			L1	L2	X1	X2		E	
N 160			1580 - 1600				2000	713	
N 140			1380 - 1400				2000	713	
N 120			1180 - 1200				2000	713	

Andromeda N 100, 90, 80

156

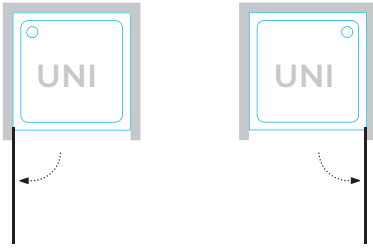

N 100, 90, 80

- Samostojna tuš vrata, enostransko odpiranje.
- Self-supporting shower door, single-side opening.
- Samostalna tuš vrata, jednostrano otvaranje.
- Samostojeća tuš vrata, jednostrano otvaranje.



Andromeda D 100, 90, 80

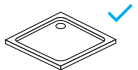
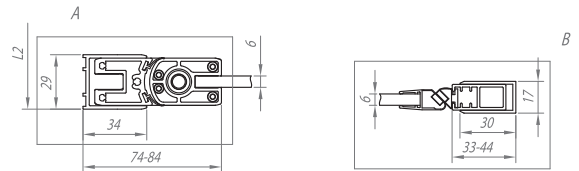
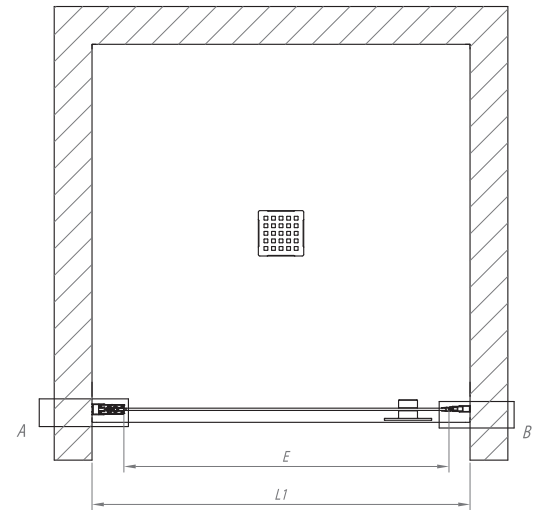

Ballo, Tello, Lavolta, Lerock zero, Ramona tray, Moonwalk, Limbo, Re-walk, Capo, Acro, Pandora Tray, Canary, Serra, Drop, Funky, Flamenco, Evelin Tray Q.

Andromeda			L1	L2	X1	X2		E	
N 100			980 - 1000				2000	870	
N 90			880 - 900				2000	770	
N 80			780 - 800				2000	670	

Andromeda D 160, 140, 120 + W 100, 90, 80

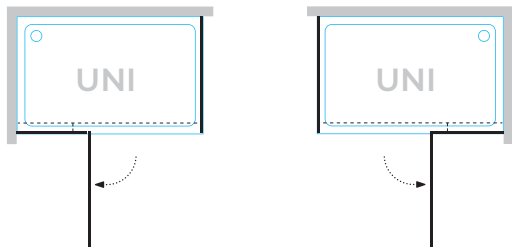

D 160, 140, 120 + W 100, 90, 80

- Tuš vrata s tuš steno.
- Shower door with shower wall.
- Tuš vrata s tuš panelom.
- Tuš vrata sa tuš zidom.

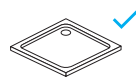
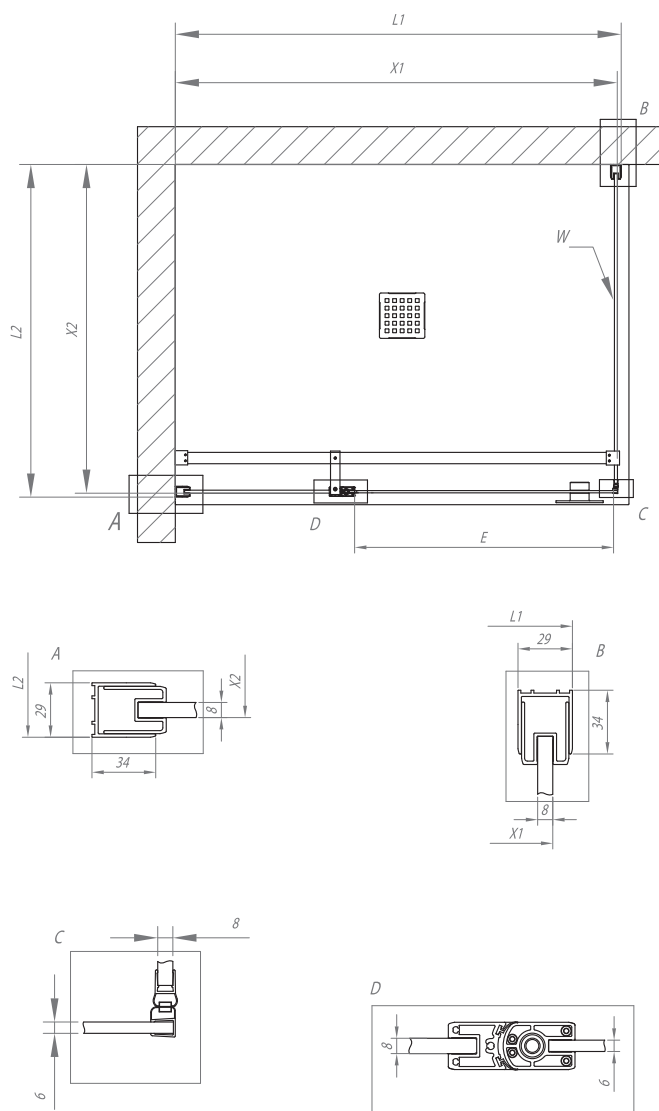

Ballo, Tello, Lavolta, Lerock zero, Ramona tray, Moonwalk, Limbo, Re-walk, Acro, Pandora Tray, Canary, Serra, Drop, Funky, Flamenco, Evelin Tray Q.

Andromeda			L1	L2	X1	X2		E	
D 160			1580 - 1590		1570 - 1580		2000	695	
D 140			1380 - 1390		1370 - 1380		2000	695	
D 120			1180 - 1190		1170 - 1180		2000	695	
W 100				980 - 990		970 - 980	2000		
W 90				880 - 890		870 - 880	2000		
W 80				780 - 790		770 - 780	2000		

Andromeda D 100, 90, 80 + W 100, 90, 80

158

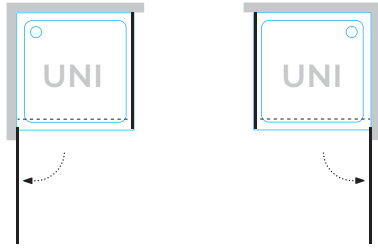

D 100, 90, 80 + W 100, 90, 80

- Tuš vrata s tuš steno.
- Shower door with shower wall.
- Tuš vrata s tuš panelom.
- Tuš vrata sa tuš zidom.

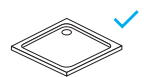
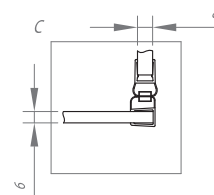
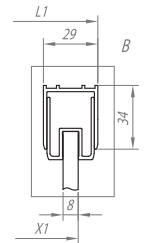
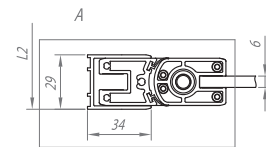
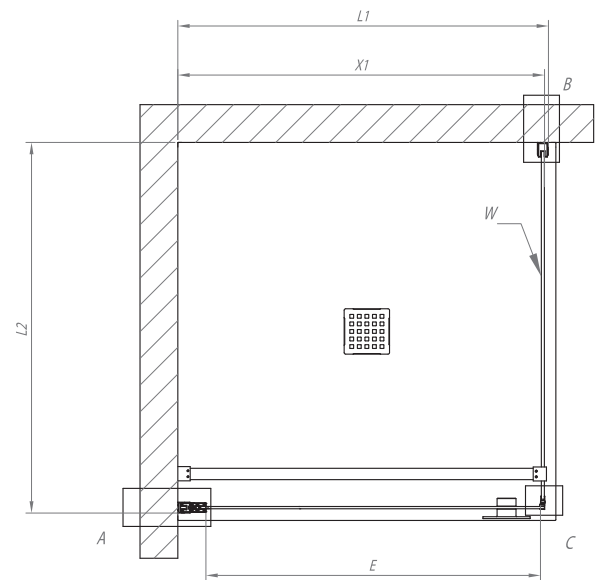

Tello, Lavolta, Lerock zero, Moonwalk, Re-walk, Capo, Acro, Pandora Tray, Canary, Serra, Drop, Flamenco, Funky, Evelin Tray Q.

Andromeda			L1	L2	X1	X2		E	
D 100			980 - 990		970 - 980		2000	895	
D 90			880 - 890		870 - 880		2000	795	
D 80			780 - 790		770 - 780		2000	695	
W 100				980 - 990		970 - 980	2000		
W 90				880 - 890		870 - 880	2000		
W 80				780 - 790		770 - 780	2000		

Andromeda D 100, 90, 80 + W 100, 90, 80









160



Atlas

ATLAS

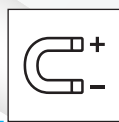
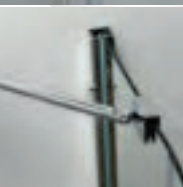

 <p>6 mm</p>	<p>6 mm kaljeno prozorno steklo 6 mm transparent tempered glass 6 mm kaljeno prozirno staklo 6 mm prozirno kaljeno staklo</p>	 
 <p>6 mm</p>	<p>6 mm Frost prozorno steklo 6 mm Frost tempered glass 6 mm Frost prozirno staklo 6 mm Frost kaljeno staklo</p>	 
<p>2000 mm</p>	<p>Silver Brill profili (visokopolirana srebrna galvanska prevleka) Silver Brill Studs (high gloss-polished silver galvanised coating) Silver Brill profili (visokopolirana srebrna galvanska prevleka) Silver Brill profili (visokopolirani srebrni galvanski premaz)</p>	  <p>SBR</p>
	<p>zapiranje z magnetnim profilom magnetic edge closure zatvaranje s magnetskim profilom zatvaranje pomoću magnetnog profila</p>	
	<p>kromirani tečaji z dvižno funkcijo chromed hinges with lift function kromirane šarke s podiznom funkcijom hromirane šarke sa funkcijom podizanja</p>	
	<p>dodatni nosilci additional brackets dodatni nosači dodatni nosači</p>	
	<p>dodatni aluminijasti profil na tuš kadi preprečuje iztekanje vode an additional aluminium edge on the shower tray prevents overflow dodatni aluminijski profil na tuš kadi sprječava istjecanje vode dodatni aluminijumski profil na tuš kadi sprečava izlivanje vode</p>	

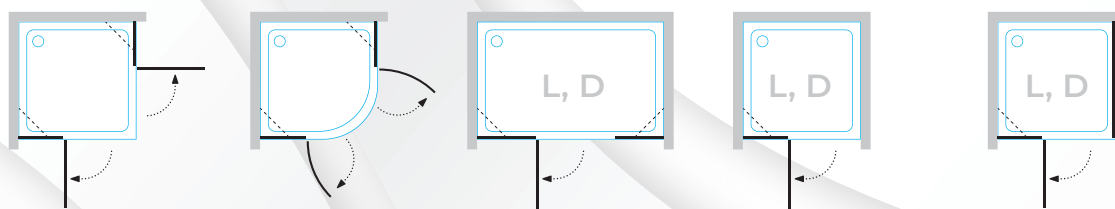

Atlas Tkk 100, 90

162

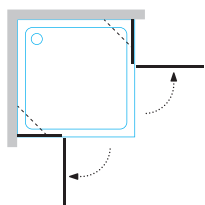

TKK 100, 90

- Kotna tuš kabina z dvema vratnima kriloma na tečajih.
- Corner shower enclosure with double-wing doors.
- Kutna tuš kabina s dva vratna krila na šarkama.
- Četrtasta tuš kabina sa dva vratna krila na šarkama.

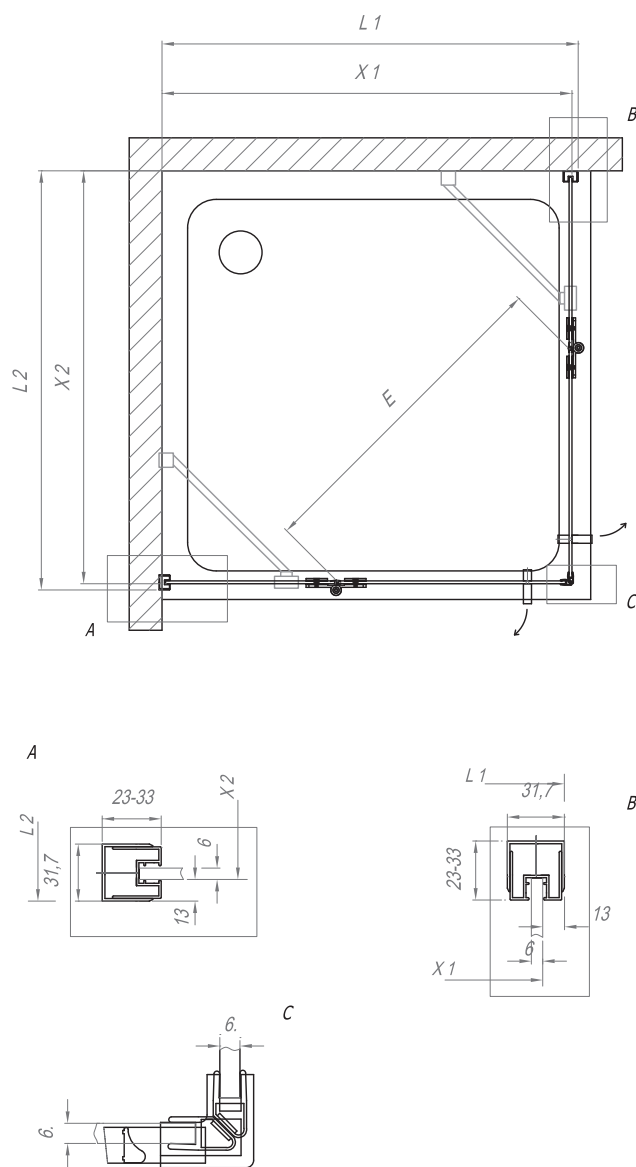
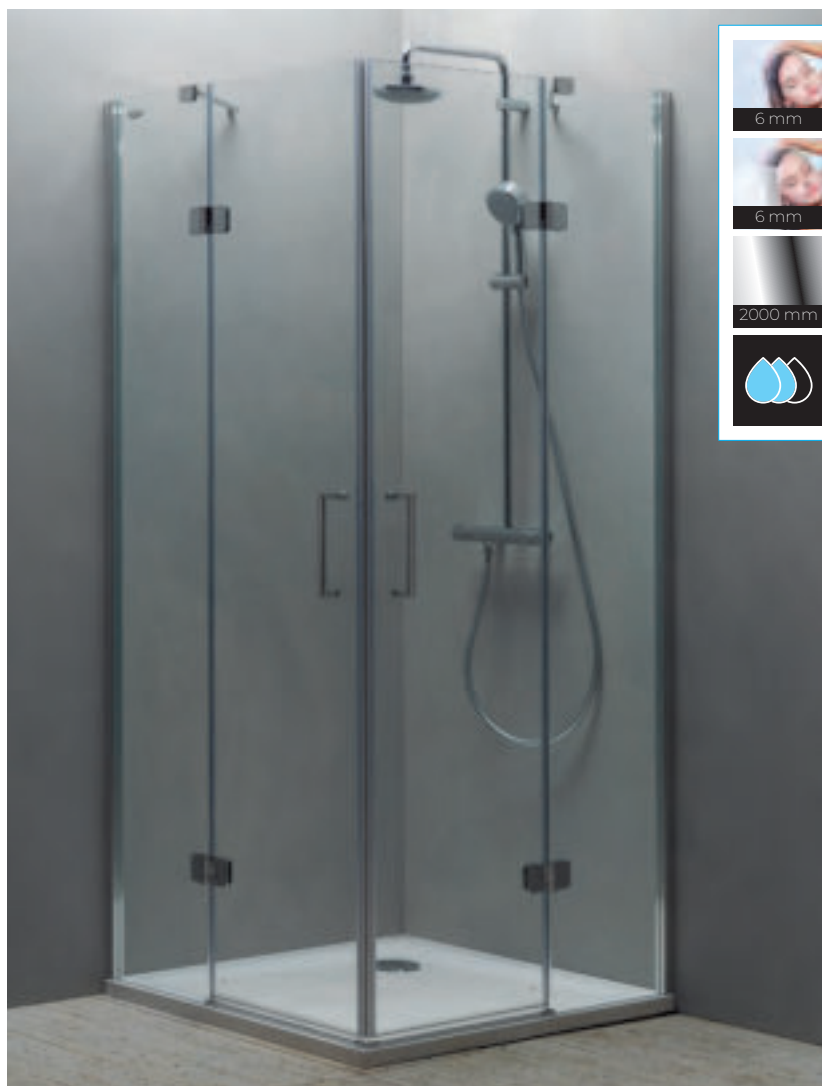

Tello, Lavolta, Lerock zero, Capo, Pandora Tray, Canary, Serra, Drop, Flamenco, Evelin Tray Q, Trin.

Atlas			L1	L2	X1	X2		E	
TKK 100 (FROST)			980 - 990	980 - 990	967 - 977	967 - 977	2000	685	
TKK 90 (FROST)			880 - 890	880 - 890	867 - 877	867 - 877	2000	685	

Atlas TKP 100, 90

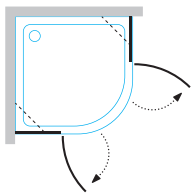

TKP 100, 90

- Polkrožna tuš kabina z dvema vratnima kriloma na tečajih.
- Semi-circular shower enclosure with double-wing doors.
- Polukružna tuš kabina s dva vratna krila na šarkama.
- Polukružna tuš kabina sa dva vratna krila na šarkama.

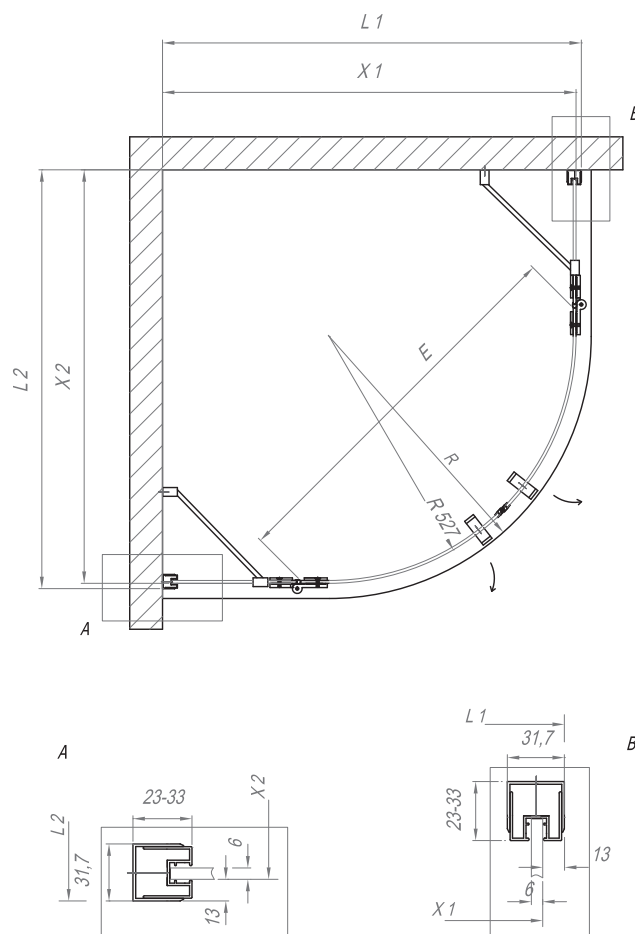

Lavolta R, Moonwalk R, Macarena, Drop R, Dixie, Evelin Tray R, Ontex.

Atlas			L1	L2	X1	X2			E	
TKP 100 (FROST)			980 - 990	980 - 990	967 - 977	967 - 977	550	2000	720	
TKP 90 (FROST)			880 - 890	880 - 890	867 - 877	867 - 877	550	2000	720	

Atlas TV/S 120/K - L, D

164

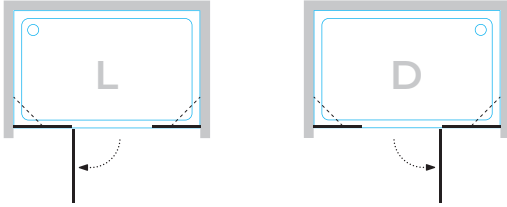

TV/S 120/K - L, D

- Samostojna tuš vrata. Možnost montaže v nišo.
- Self-supporting shower door. Installed in a recess.
- Samostoječa tuš vrata. Mogućnost montaže u nišu.
- Samostojeća vrata. Mogućnost montaže u nišu.

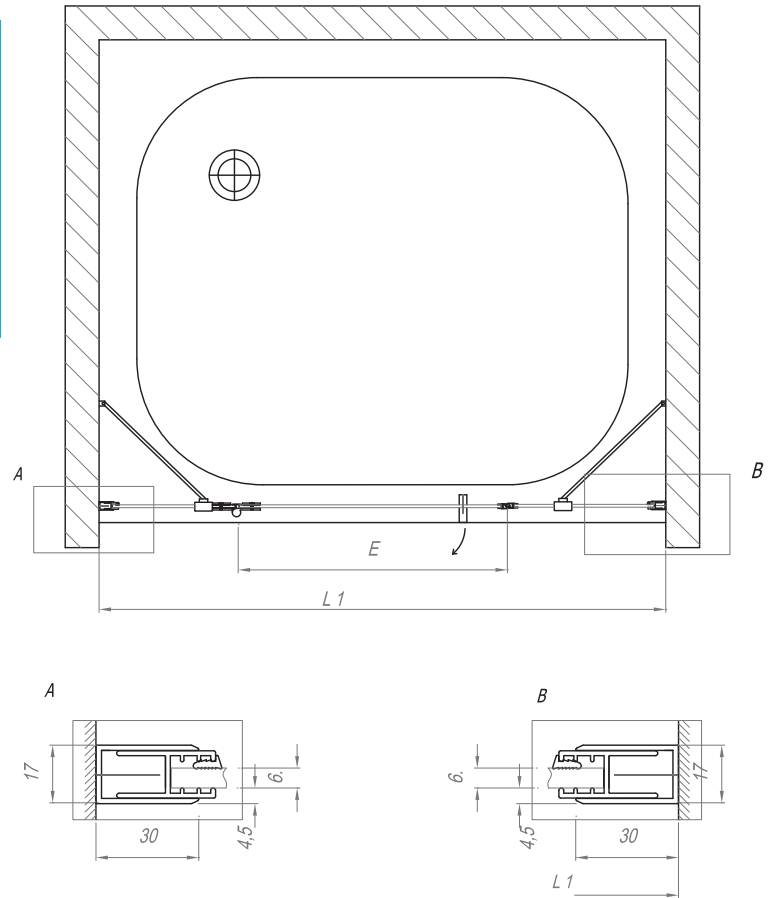

Atlas TV/S 120 /K- L, R

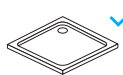

Ballo, Tello, Lavolta, Lerock zero, Ramona tray, Moonwalk, Limbo, Re-walk, Capo, Acro, Pandora Tray, Canary, Serra, Drop, Flamenco, Funky, Evelin Tray Q.

Atlas TV/S 100, 90/K - L, D

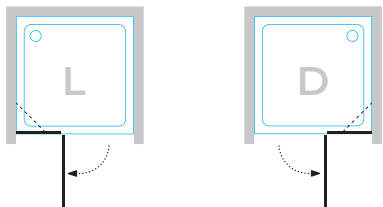

TV/S 100, 90 - L, D

- Samostojna tuš vrata. Možnost montaže v nišo.
- Self-supporting shower door. Installed in a recess.
- Samostoječa tuš vrata. Mogućnost montaže u nišu.
- Samostojeća vrata. Mogućnost montaže u nišu.

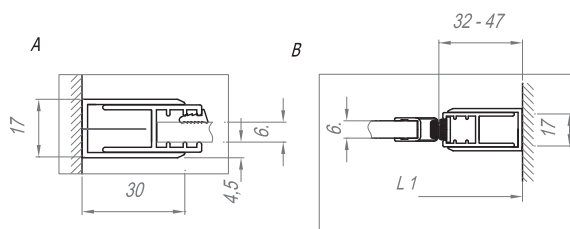
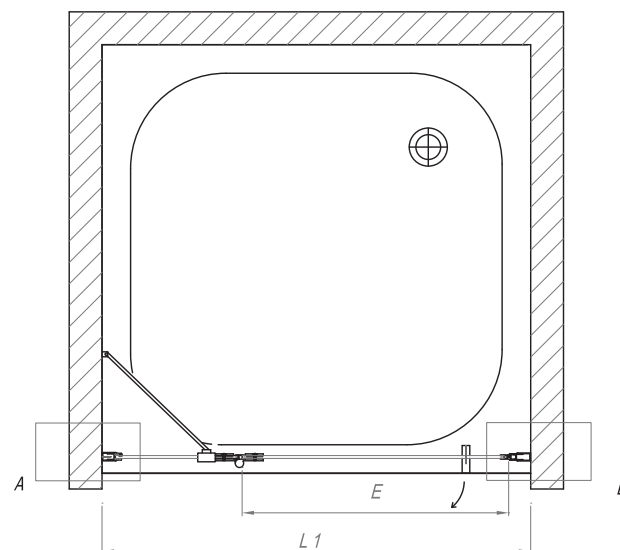

✓ Tello, Lavolta, Lerock zero, Ramona tray, Moonwalk, Limbo, Re-walk, Capo, Acro, Pandora Tray, Canary, Serra, Drop, Flamenco, Funky, Evelin Tray Q, Trin.

Atlas			L1	L2	X1	X2		E	
TV/S 100/K -L, D			980 - 1000				2000	530	
TV/S 90/K -L, D			880 - 900				2000	530	

Atlas TV/S 120, 100, 90/K - L, R + TSv 90, 80/K

166

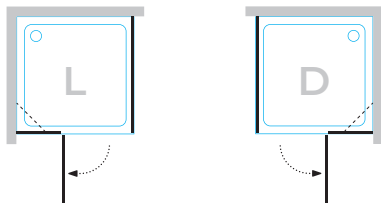

TV/S 100, 90/K - L, D + TSv 90, 80/K

- Tuš vrata s tuš steno.
- Shower door with shower wall.
- Tuš vrata s tuš panelom.
- Tuš vrata sa tuš zidom.

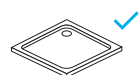
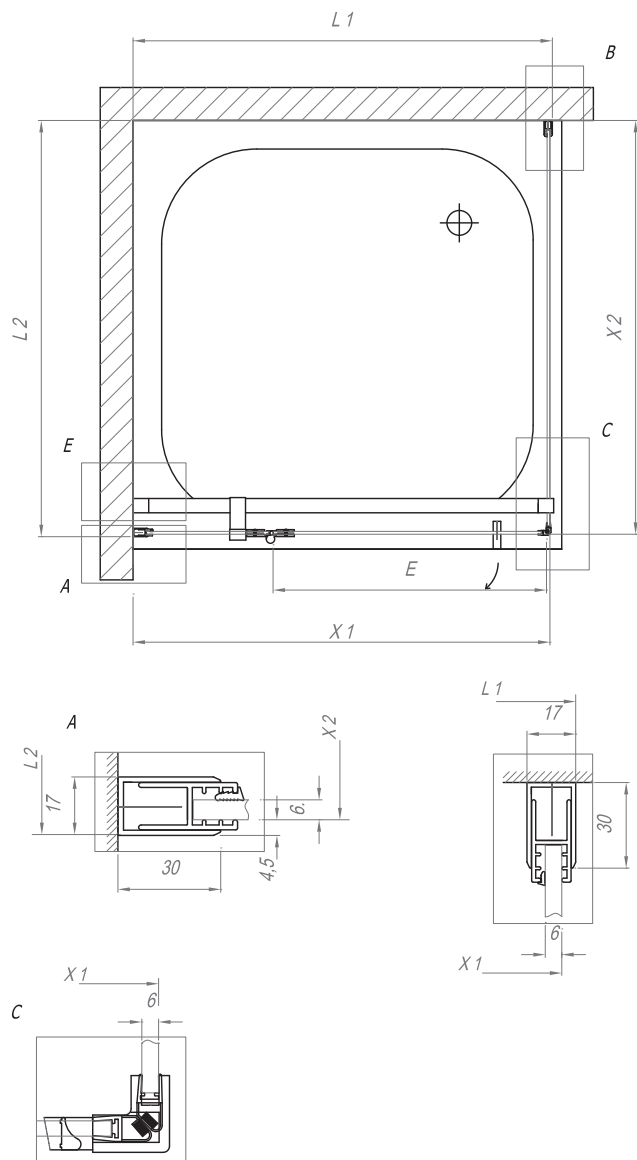

Tello, Lavolta, Lerock zero, Ramona tray, Moonwalk, Limbo, Re-walk, Capo, Acro, Pandora Tray, Canary, Serra, Drop, Flamenco, Funky, Evelin Tray Q, Trin.

Atlas			L1	L2	X1	X2		E	
TV 120/K -L, D			1180 - 1190		1175 - 1185		2000	570	
TV 100/K -L, D			980 - 990		975 - 985		2000	530	
TV 90/K -L, D			880 - 900		875 - 885		2000	530	
TSv 90/K -L, D				880 - 890		875 - 885	2000		
TSv 80/K -L, D				780 - 790		775 - 785	2000		





CALYPSO



 <p>8 mm</p>	<p>8 mm kaljeno prozorno steklo 8 mm transparent tempered glass 8 mm kaljeno prozirno staklo 8 mm prozirno kaljeno staklo</p>	 
 <p>8 mm</p>	<p>8 mm graphite kaljeno steklo 8 mm graphite tempered glass 8 mm graphite kaljeno staklo 8 mm graphite kaljeno staklo</p>	 
 <p>2000 mm</p>	<p>Silver Brill profili (visokopolirana srebrna galvanska prevleka) Silver Brill Studs (high gloss-polished silver galvanised coating) Silver Brill profili (visokopolirana srebrna galvanska prevlaka) Silver Brill profili (visokopolirani srebrni galvanski premaz)</p>	 
 <p>2000 mm</p>	<p>BLACK (črni) profili, prašno lakiranje BLACK profiles, powder coating BLACK (crni) profili, lakiranje prahom BLACK (crni) profili, suvo lakiranje</p>	 
	<p>opora za stabilnost tuš kabine support for the stability of the shower enclosure potpora za stabilnost tuš kabine oslonac za stabilnost tuš kabine</p>	
	<p>Clean coat, zaščitni premaz Clean coat, protective coating Clean coat, zaštitni premaz Clean coat, zaštitni premaz</p>	

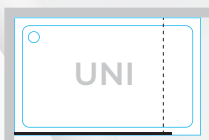
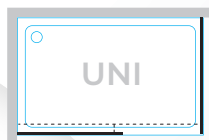

Calypso WIN 160, 140

170

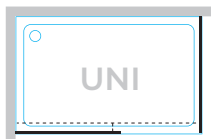

WIN 160, 140

- Tuš kabina z možnostjo postavitve na tuš kad ali samostojne vgradnje (brez tuš kade).
- Tuš kabina s možnostjo postavljanja na tuš kadu ili izravno na tlo (bez tuš kade).
- Tuš kabina s možnostjo postavljanja na tuš kadu ili izravno na tlo (bez tuš kade).
- Tuš kabina sa mogućnošću montaže na tuš kadu ili direktno na pod (bez tuš kade).

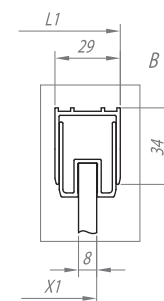
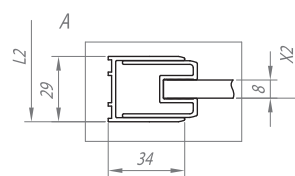
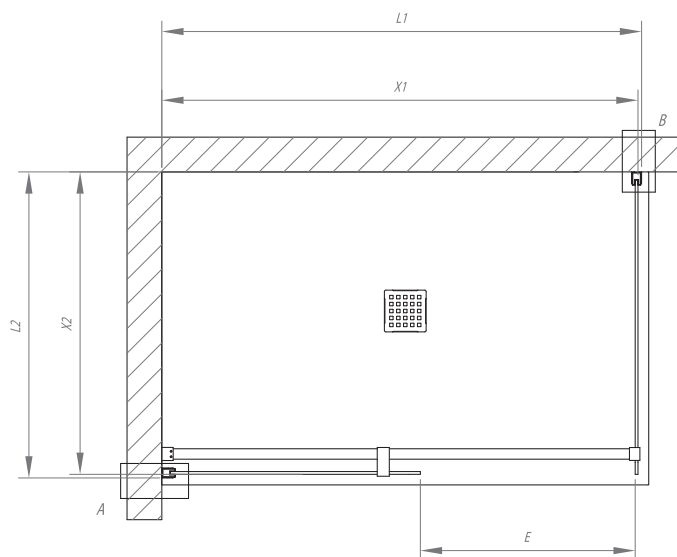

Calypso WIN 160, 140

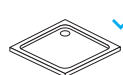

Ballo, Tello, Lavolta, Lerock zero, Ramona tray, Moonwalk, Limbo, Re-walk, Capo, Acro, Pandora Tray, Canary, Serra, Drop, Flamenco, Evelin Tray Q.

Calypso			L1	L2	X1	X2		E	
WIN 160x100			1580 - 1590	980 - 990	1570 - 1580	970 - 980	2000	617	
WIN 160x90			1580 - 1590	880 - 890	1570 - 1580	870 - 880	2000	617	
WIN 160x80			1580 - 1590	780 - 790	1570 - 1580	770 - 780	2000	617	
WIN 140x100			1380 - 1390	980 - 990	1370 - 1380	970 - 980	2000	617	
WIN 140x90			1380 - 1390	880 - 890	1370 - 1380	870 - 880	2000	617	
WIN 140x80			1380 - 1390	780 - 790	1370 - 1380	770 - 780	2000	617	

Calypso WO 140, 120, 100

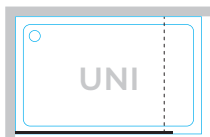

WO 140, 120, 100

- Tuš stena z možnostjo postavitve na tuš kad ali direktno na tla (brez tuš kadi).
- Shower wall that can either be installed on a shower tray or directly on the floor (no shower tray required).
- Tuš zid sa mogućnošću montaže na tuš kadu ili direktno na pod (bez tuš kade).
- Zuhanykádra illetve közvetlen a padlóra (zuhanykád nélkül) állítható OPEN zuhany – zuhanyfal.

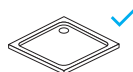
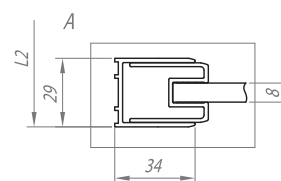
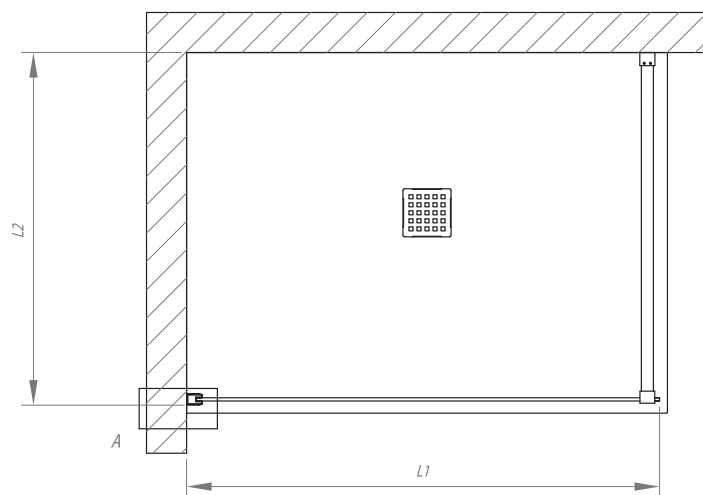



















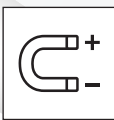

Ballo, Tello, Lavolta, Lerock zero, Ramona tray, Moonwalk, Limbo, Re-walk, Capo, Acro, Pandora Tray, Canary, Serra, Drop, Flamenco, Evelin Tray Q.

Calypso			L1	L2	X1	X2		E	
WO 140			1380 - 1390	max 1200			2000		
WO 120			1180 - 1190	max 1200			2000		
WO 100			980 - 990	max 1200			2000		



Virgo UNI

VIRGO UNI

 8 mm	<p>8 mm kaljeno prozorno steklo 8 mm transparent tempered glass 8 mm kaljeno prozirno staklo 8 mm prozirno kaljeno staklo</p>	 
 2000 mm	<p>Silver Brill profili (visokopolirana srebrna galvanska prevleka) Silver Brill Studs (high gloss-polished silver galvanised coating) Silver Brill profili (visokopolirana srebrna galvanska prevleka) Silver Brill profili (visokopolirani srebrni galvanski premaz)</p>	 
 2000 mm	<p>BLACK (črni) profili, prašno lakiranje BLACK profiles, powder coating BLACK (crni) profili, lakiranje prahom BLACK (crni) profili, suvo lakiranje</p>	 
 	<p>zapiranje z magnetnim profilom magnetic edge closure zatvaranje s magnetskim profilom zatvaranje pomoću magnetnog profila</p>	
 	<p>vratno krilo na masivnih krogličnih ležajih door leaf on solid bail bearings vratno krilo na masivnim kugličnim ležajevima krilo vrata na masivnim kugličnim ležajevima</p>	
 	<p>demontažni čep omogoča lažje čiščenje mounting plug allows easier cleaning demontažni čep omogočuje lakše čiščenje demontažni čep omogočava lakše čiščenje</p>	
 	<p>držalo za brisače towel holder držač ručnika držač za peškire</p>	
 	<p> dodatni aluminijasti profil na tuš kadi preprečuje iztekanje vode an additional aluminium edge on the shower tray prevents overflow dodatni aluminijski profil na tuš kadi sprječava istjecanje vode dodatni aluminijumski profil na tuš kadi sprečava izlivanje vode</p>	
 kolpa Clean Coat®	<p>Clean coat, zaščitni premaz Clean coat, protective coating Clean coat, zaštitni premaz Clean coat, zaštitni premaz</p>	



Virgo UNI TK 160, 140, 120

174

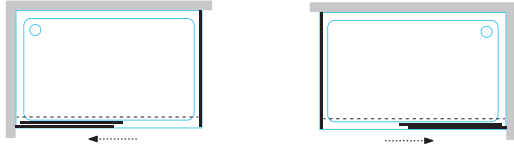

TK 160, 140, 120

- Tuš kabina - vrata in stena, levo ali desno enostransko odpiranje.
- Shower enclosure - door and wall, left or right-side opening
- Tuš kabina - vrata i stijena, lijevo ili desno jednostrano otvaranje
- Tuš kabina - vrata i zid, levo ili desno jednostrano otvaranje

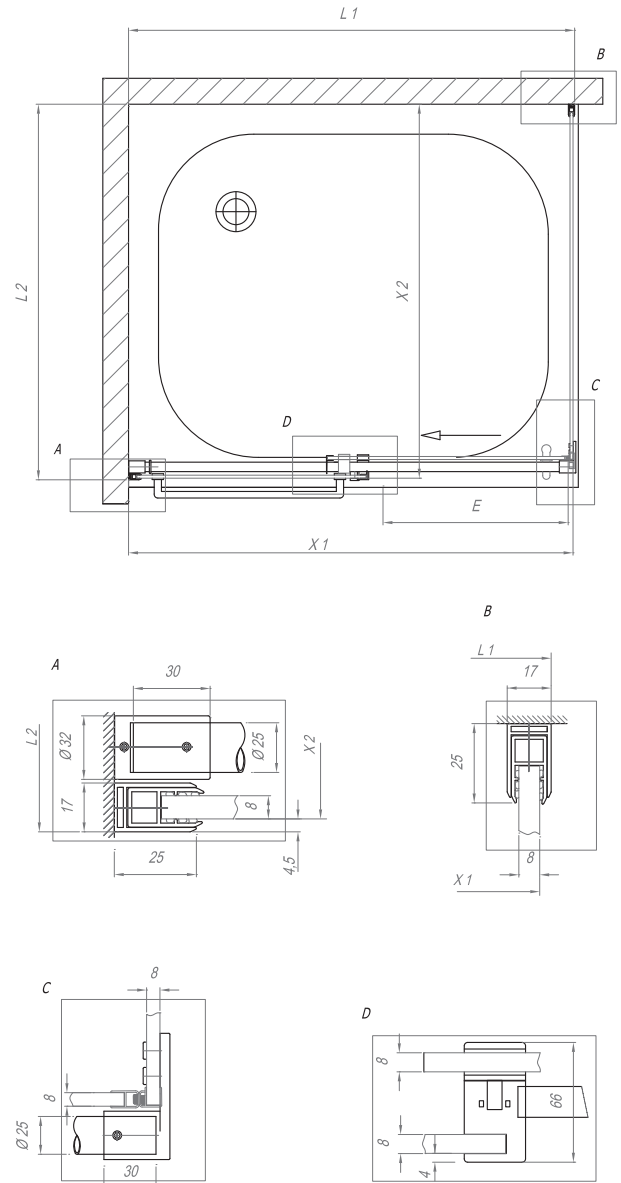

Virgo UNI TK 160, 140, 120

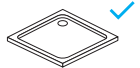

Ballo, Tello, Lavolta, Lerock zero, Ramona tray, Moonwalk, Limbo, Re-walk, Capo, Acro, Pandora Tray, Canary, Serra, Drop, Flamenco, Funky, Evelin Tray Q.

Virgo UNI			L1	L2	X1	X2		E	
TK 160 x 90			1585 - 1590	890 - 895	1580 - 1585	885 - 890	2000	660	
TK 160 x 80			1585 - 1590	790 - 795	1580 - 1585	785 - 790	2000	660	
TK 140 x 90			1385 - 1390	890 - 895	1380 - 1385	885 - 890	2000	560	
TK 140 x 80			1385 - 1390	790 - 795	1380 - 1385	785 - 790	2000	560	
TK 120 x 90 (BLACK)			1185 - 1190	890 - 895	1180 - 1185	885 - 890	2000	460	
TK 120 x 80 (BLACK)			1185 - 1190	790 - 795	1180 - 1185	785 - 790	2000	460	

Virgo UNI TV2D/S 160, 140, 120

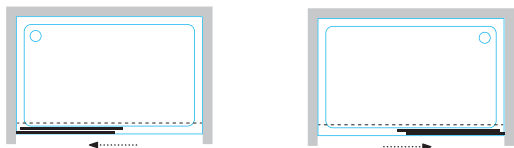

TV2D/S 160, 140, 120

- Samostojna tuš vrata, enostransko odpiranje.
- Self-supporting shower door, single-side opening.
- Samostalna tuš vrata, jednostrano otvaranje.
- Samostojeća tuš vrata, jednostrano otvaranje.

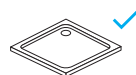
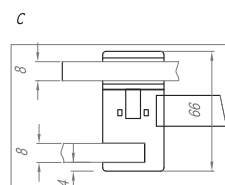
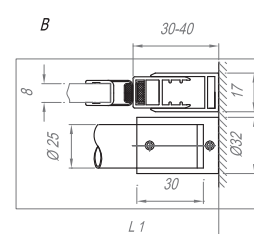
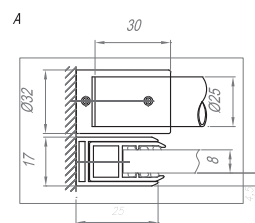
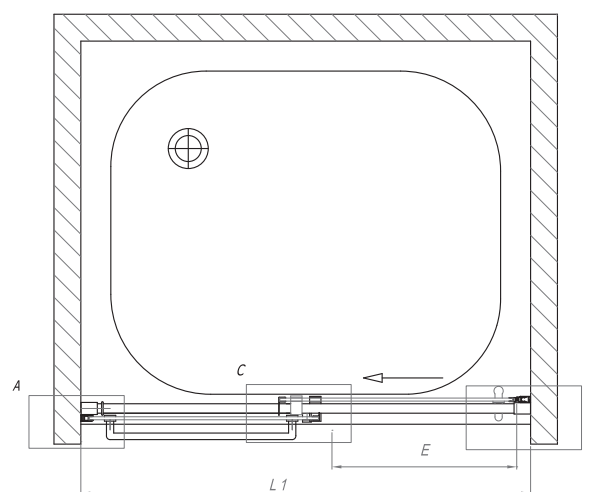

Ballo, Tello, Lavolta, Lerock zero, Ramona tray, Moonwalk, Limbo, Re-walk, Capo, Acro, Pandora Tray, Canary, Serra, Drop, Flamenco, Funky, Evelin Tray Q.

Virgo UNI			L1	L2	X1	X2		E	
TV2D/S 160			1580 - 1600				2000	660	
TV2D/S 140			1380 - 1400				2000	560	
TV2D/S 120			1180 - 1200				2000	460	



Montes

MONTES

 8 mm	<p>8 mm kaljeno prozorno steklo 8 mm transparent tempered glass 8 mm kaljeno prozirno staklo 8 mm prozirno kaljeno staklo</p>	 
 2000 mm	<p>Silver Brill profili (visokopolirana srebrna galvanska prevleka) Silver Brill Studs (high gloss-polished silver galvanised coating) Silver Brill profili (visokopolirana srebrna galvanska prevleka) Silver Brill profili (visokopolirani srebrni galvanski premaz)</p>	 
	<p>zapiranje z magnetnim profilom magnetic edge closure zatvaranje s magnetnim profilom zatvaranje pomoću magnetnog profila</p>	
	<p>demontažni pokrov demounting cover demontažni poklopac demontažni poklopac</p>	
	<p> dodatni aluminijasti profil na tuš kadi preprečuje iztekanje vode an additional aluminium edge on the shower tray prevents overflow dodatni aluminijski profil na tuš kadi sprječava istjecanje vode dodatni aluminijumski profil na tuš kadi sprečava izlivanje vode</p>	

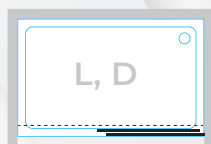
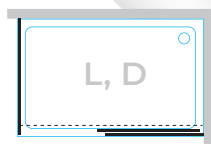

Montes TK 140, 120 - L, D

178

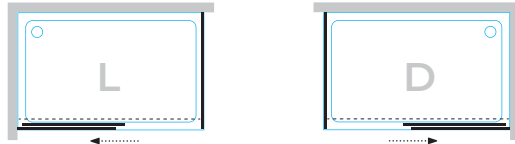

TK 140, 120

- Tuš kabina - vrata in stena, levo ali desno enostransko odpiranje.
- Shower enclosure - door and wall, left or right-side opening
- Tuš kabina - vrata i stijena, lijevo ili desno jednostrano otvaranje
- Tuš kabina - vrata i zid, levo ili desno jednostrano otvaranje

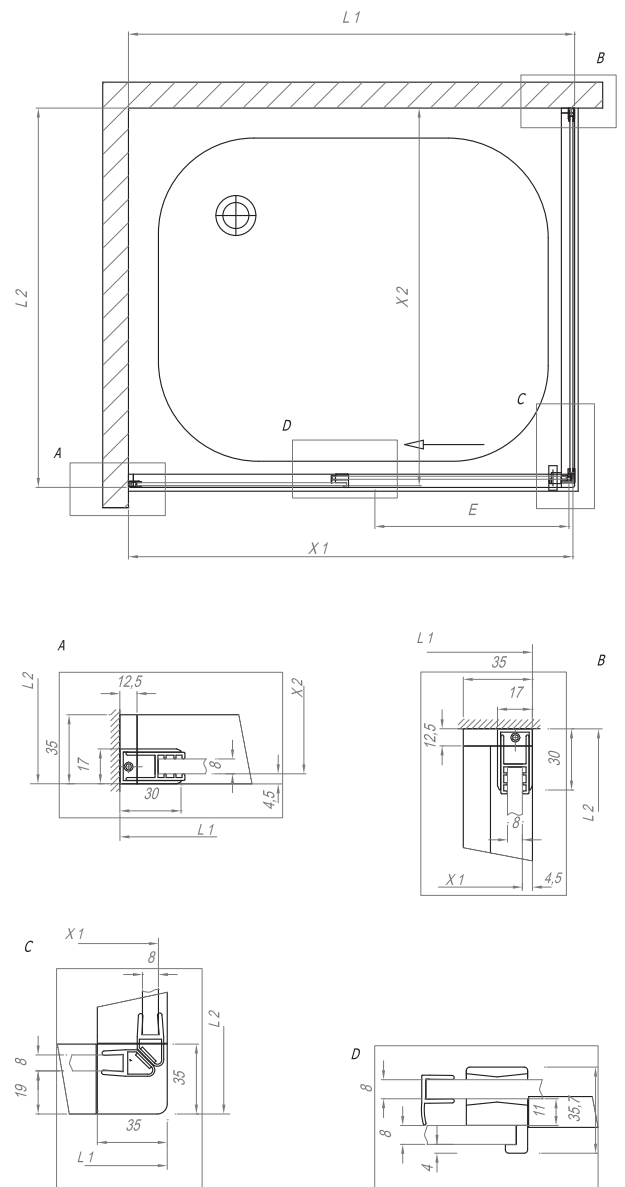
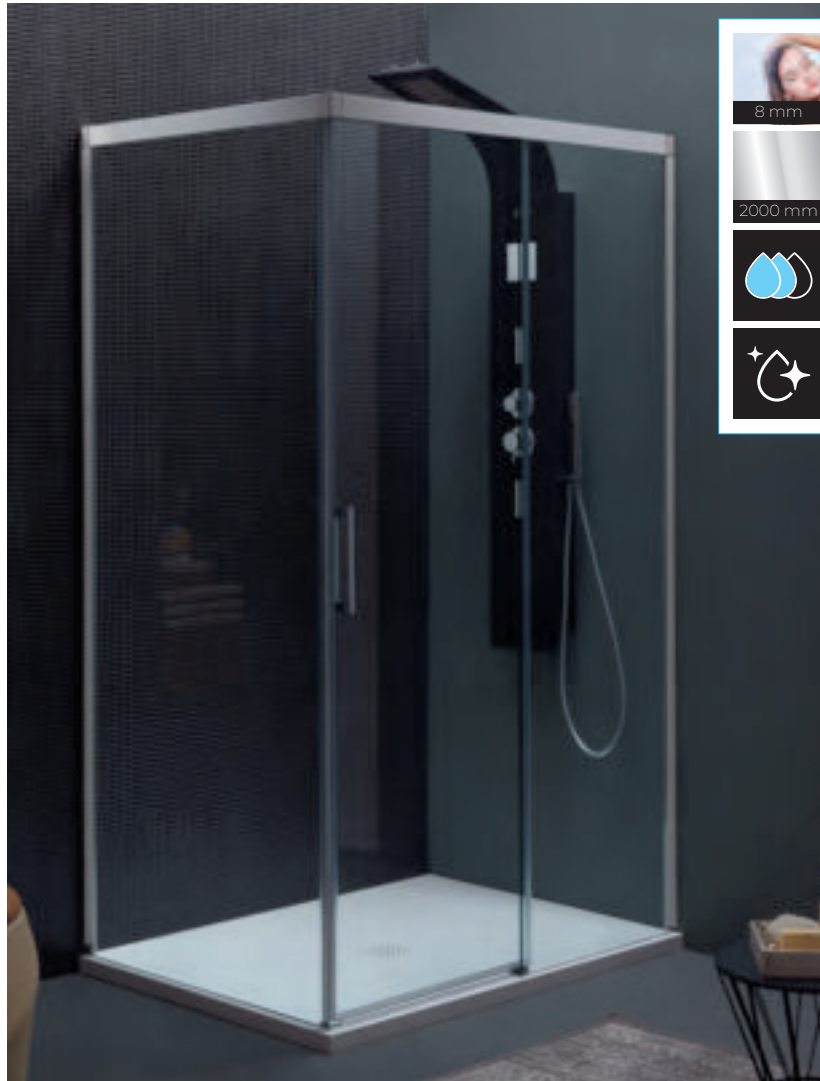

Montes TK 160, 140, 120 - L, D



Ballo, Tello, Lavolta, Lerock zero, Ramona tray, Moonwalk, Limbo, Re-walk, Capo, Acro, Pandora Tray, Canary, Serra, Drop, Flamenco, Funky, Evelin Tray Q.

Montes			L1	L2	X1	X2		E	
TK 140 x 90 -L, D			1380	880	1375	875	2000	560	
TK 140 x 80 -L, D			1380	780	1375	775	2000	560	
TK 120 x 90 -L, D			1180	880	1175	875	2000	460	
TK 120 x 80 -L, D			1180	780	1175	775	2000	460	

Montes TV2D/S 140, 120 - L, D

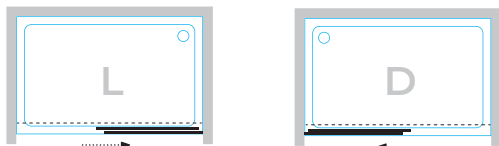

TV2D/S 140, 120

- Samostojna tuš vrata, enostransko odpiranje.
- Self-supporting shower door, single-side opening.
- Samostalna tuš vrata, jednostrano otvaranje.
- Samostojeća tuš vrata, jednostrano otvaranje.

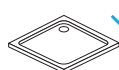
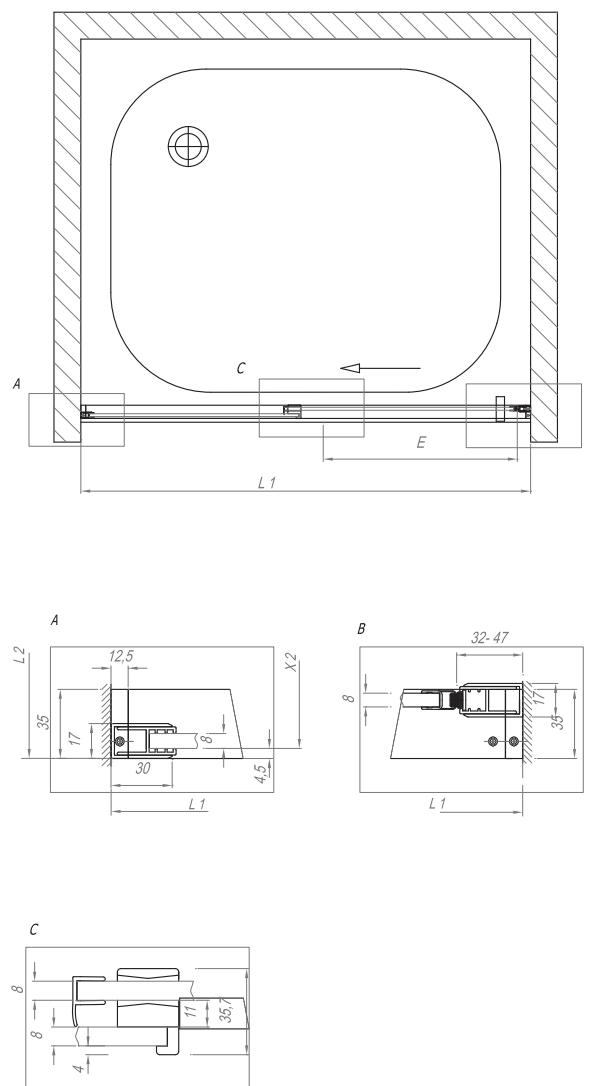
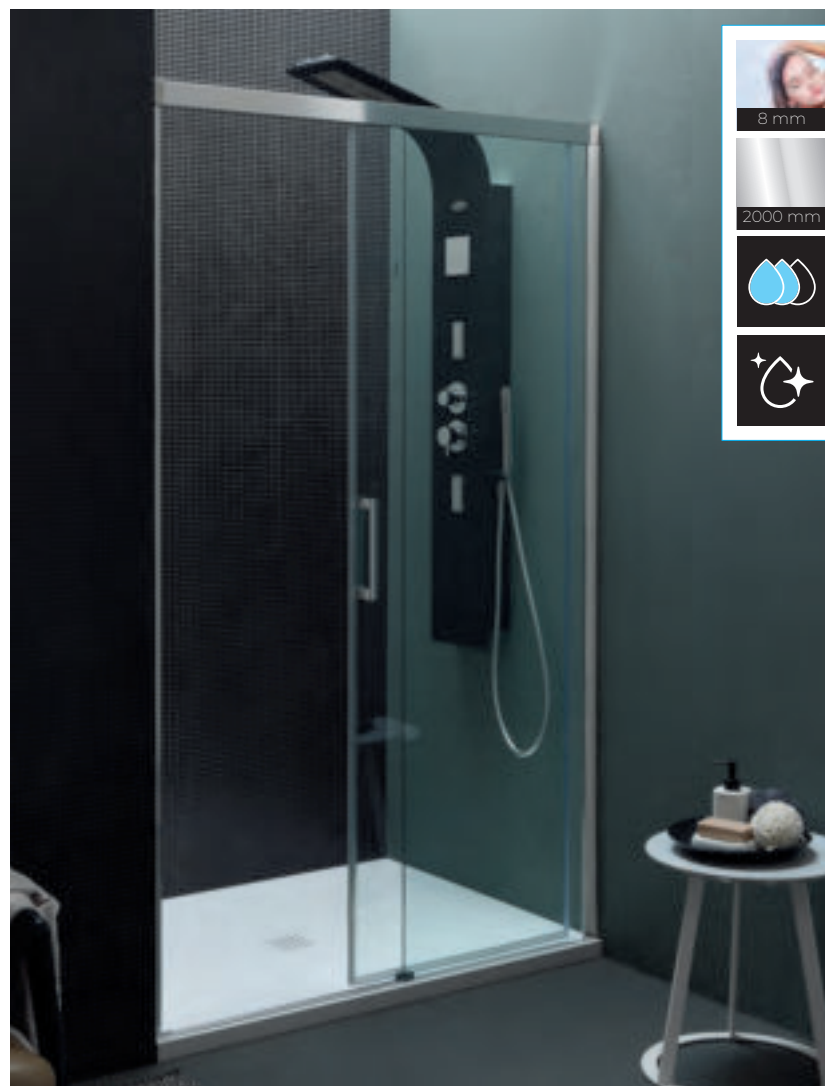

Ballo, Tello, Lavolta, Lerock zero, Ramona tray, Moonwalk, Limbo, Re-walk, Capo, Acro, Pandora Tray, Canary, Serra, Drop, Flamenco, Funky, Evelin Tray Q.

Montes			L1	L2	X1	X2		E	
TV2D/S 140 -L, D			1385- 1400				2000	597	
TV2D/S 120 -L, D			1185- 1200				2000	497	

180



Dorsa UNI

DORSA UNI

 8 mm	<p>8 mm kaljeno prozorno steklo 8 mm transparent tempered glass 8 mm kaljeno prozirno staklo 8 mm prozirno kaljeno staklo</p>	 
 2000 mm	<p>Silver Brill profili (visokopolirana srebrna galvanska prevleka) Silver Brill Studs (high gloss-polished silver galvanised coating) Silver Brill profili (visokopolirana srebrna galvanska prevleka) Silver Brill profili (visokopolirani srebrni galvanski premaz)</p>	 
	<p>zapiranje z magnetnim profilom magnetic edge closure zatvaranje s magnetskim profilom zatvaranje pomoću magnetnog profila</p>	
	<p> dodatni aluminijasti profil na tuš kadi preprečuje iztekanje vode an additional aluminium edge on the shower tray prevents overflow dodatni aluminijski profil na tuš kadi sprječava istjecanje vode dodatni aluminijumski profil na tuš kadi sprečava izlivanje vode</p>	
	<p>Clean coat, zaščitni premaz Clean coat, protective coating Clean coat, zaštitni premaz Clean coat, zaštitni premaz</p>	



Dorsa TK 140, 120 UNI

182

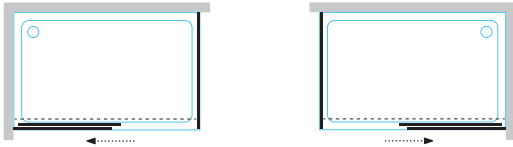

TK 140, 120

- Tuš kabina - vrata in stena, levo ali desno enostransko odpiranje, univerzalna.
- Shower enclosure - door and wall, left or right-side opening, universal.
- Tuš kabina - vrata i stijena, lijevo ili desno jednostrano otvaranje, univerzalan.
- Tuš kabina - vrata i zid, levo ili desno jednostrano otvaranje, univerzalni.

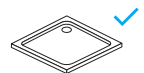
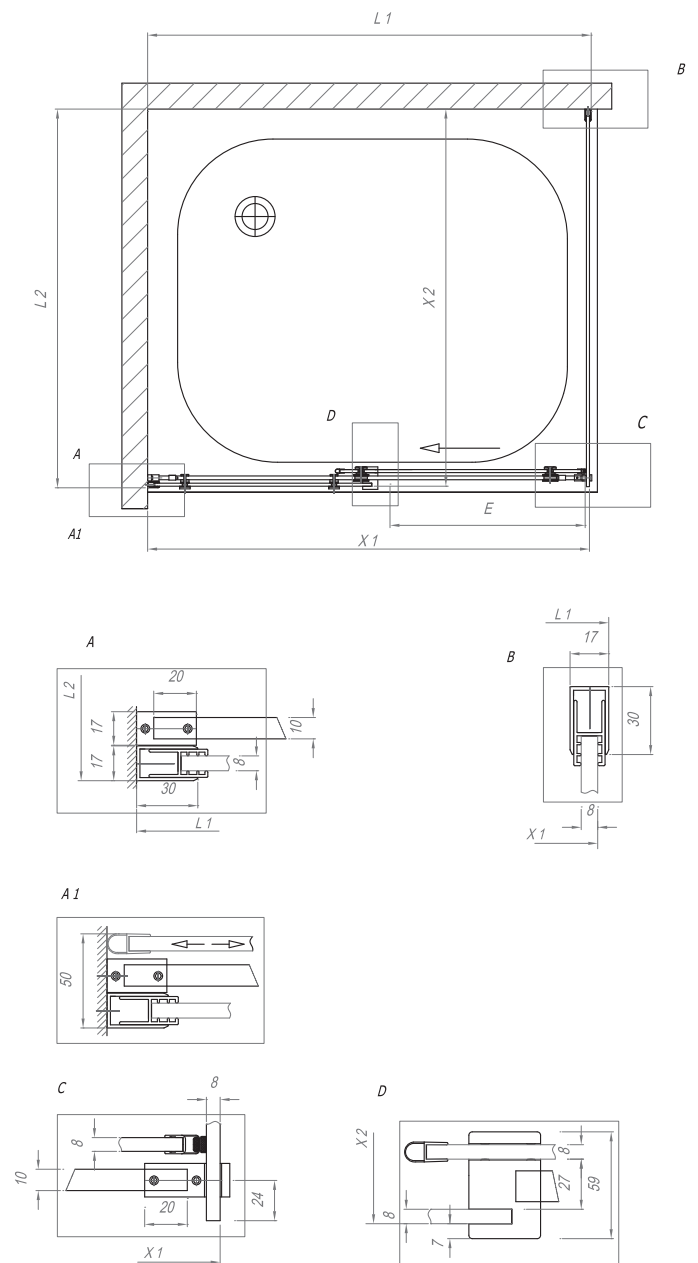

Ballo, Tello, Lavolta, Lerock zero, Ramona tray, Moonwalk, Limbo, Re-walk, Capo, Acro, Pandora Tray, Canary, Serra, Drop, Flamenco, Evelin Tray Q

Dorsa			L1	L2	X1	X2		E	
TK 140 x 90			1370 - 1440	885 - 895	1366 - 1436	881 - 891	2000	600 - 670	
TK 140 x 80			1370 - 1440	785 - 795	1366 - 1436	781 - 791	2000	600 - 670	
TK 120 x 90			1170 - 1240	885 - 895	1166 - 1236	881 - 891	2000	500 - 570	
TK 120 x 80			1170 - 1240	785 - 795	1166 - 1236	781 - 791	2000	500 - 570	

Dorsa TV2D/S 140, 120 UNI

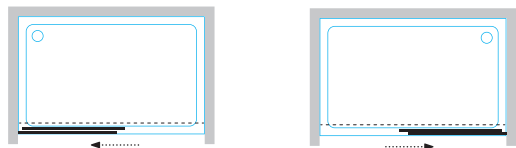

TV2D/S 140, 120

- Samostojna tuš vrata, enostransko odpiranje, univerzalna.
- Self-supporting shower door, single-side opening, universal.
- Samostalna tuš vrata, jednostrano odpiranje, univerzalna.
- Samostojeća tuš vrata, jednostrano odpiranje, univerzalni.

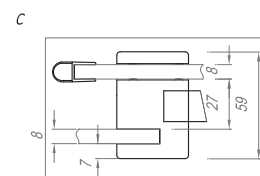
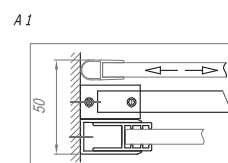
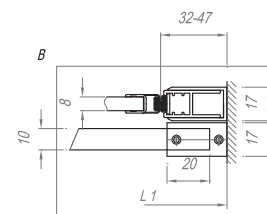
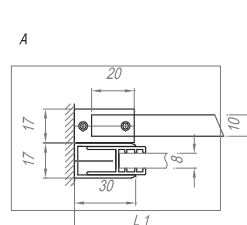
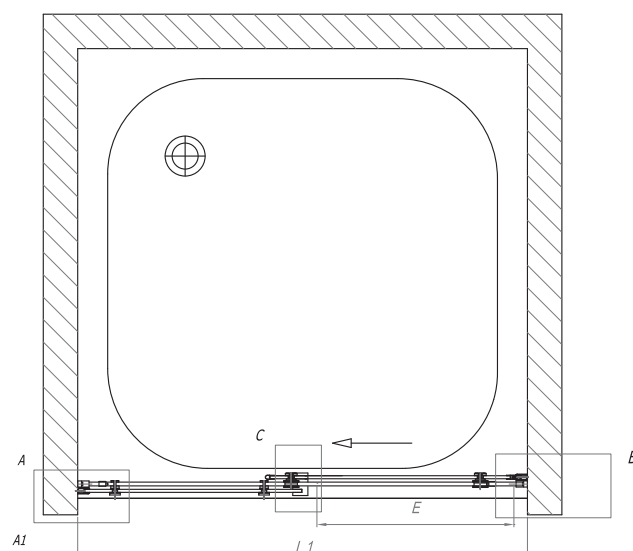

Ballo, Tello, Lavolta, Lerock zero, Ramona tray, Moonwalk, Limbo, Re-walk, Capo, Acro, Pandora Tray, Canary, Serra, Drop, Flamenco, Evelin Tray Q.











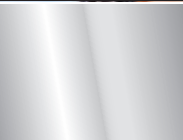

Dorsa TV2D/S 140, 120 UNI

Dorsa			L1	L2	X1	X2		E	
TV2D/S 140			1370 - 1450				2000	575 - 655	
TV2D/S 120			1170 - 1250				2000	475 - 555	

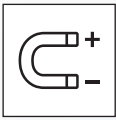

Pulsar

PULSAR

 <p>6 mm</p>	<p>6 mm kaljeno prozorno steklo 6 mm transparent tempered glass 6 mm kaljeno prozirno staklo 6 mm prozirno kaljeno staklo</p>	 
 <p>2000 mm</p>	<p>Silver profili (srebrna galvanska prevleka) Silver Studs (silver galvanised coating) Silver profili (srebrna galvanska prevlaka) Silver profili (srebrni galvanski premaz)</p>	 
	<p>zapiranje z magnetnim profilom magnetic edge closure zatvaranje s magnetskim profilom zatvaranje pomoću magnetnog profila</p>	
	<p>snemljiva vratna krila omogočajo lažje čiščenje detachable door panels for easy cleaning vratna krila na skidanje omogočuju lakše čiščenje vratna krila sa mogućnošću skidanja omogućavaju lakše čiščenje</p>	
	<p>spodnje demontažno vodilo lower removable guide donja demontažna vodilica donja demontažna vođica</p>	
	<p>nizek spodnji profil low bottom profile nizak donji profil nizak donji profil</p>	

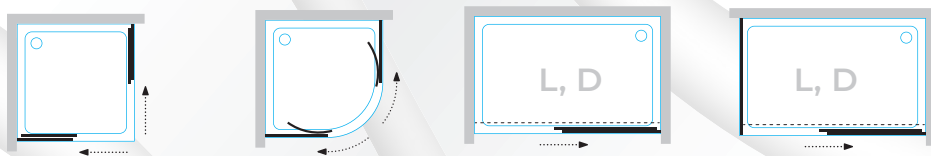

Pulsar TKK 100, 90

186



TKK 100, 90

- **Kotna tuš kabina.** Snemljivi vratni krili na krogličnih ležajih, ki omogočajo lažje čiščenje. Možnost postavitve ob eni steni s pomočjo dodatne tuš stene.
- **Corner shower enclosure.** Door panels on ball bearings, detachable for easier cleaning. Possibility of being mounted on one wall with the help of an additional shower wall.
- **Kutna tuš kabina.** Vratna krila na kugličnim ležajevima koja se mogu skidati i tako omogućavaju lakše čišćenje. Mogućnost ugradnje uz jedan zid uz pomoć dodatne tuš stijene.
- **Četvrtasta tuš kabina.** Krila sa mogućnošću skidanja na kugličnim ležajevima koja omogućavaju lakše čišćenje. Mogućnost postavljanja uz jedan zid uz pomoć dodatnog tuš stuba.

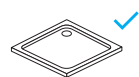
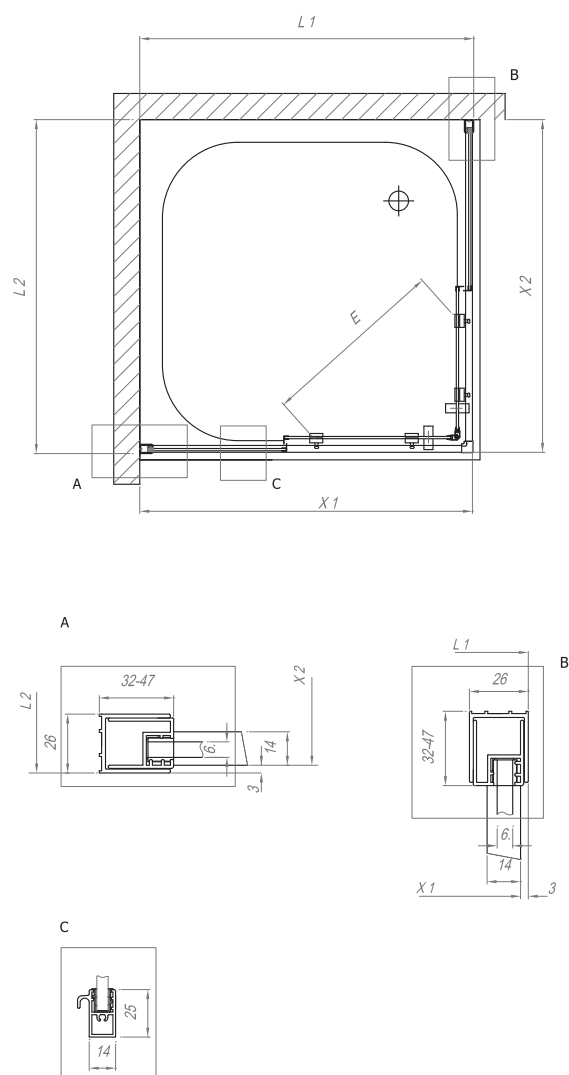

Tello, Lavolta, Lerock zero, Ramona tray, Moonwalk, Funky, Limbo, Re-walk, Capo, Acro, Pandora Tray, Canary, Serra, Drop, Flamenco, Evelin Tray Q, Trin.

Pulsar			L1	L2	X1	X2		E	
TKK 100			985 - 1000	985 - 1000	982 - 997	982 - 997	2000	510	
TKK 90			885 - 900	885 - 900	882 - 897	882 - 897	2000	495	

Pulsar TKP 100, 90

187



TKP 100, 90

- **Polkrožna tuš kabina.** Snemljivi vratni krila na krogličnih ležajjih, ki omogočajo lažje čiščenje. Možnost postavitve ob eni steni s pomočjo dodatne tuš stene.
- **Semi-circular shower enclosure.** Door panels on ball bearings, detachable for easier cleaning. Possibility of being mounted on one wall with the help of an additional shower wall.
- **Polukružna tuš kabina.** Vratna krila na kugličnim ležajevima koja se mogu skidati i tako omogućavaju lakše čišćenje. Mogućnost ugradnje uz jedan zid uz pomoć dodatne tuš stijene.
- **Polukružna tuš kabina.** Krila sa mogućnošću skidanja na kugličnim ležajevima koja omogućavaju lakše čišćenje. Mogućnost postavljanja uz jedan zid uz pomoć dodatnog tuš stuba.

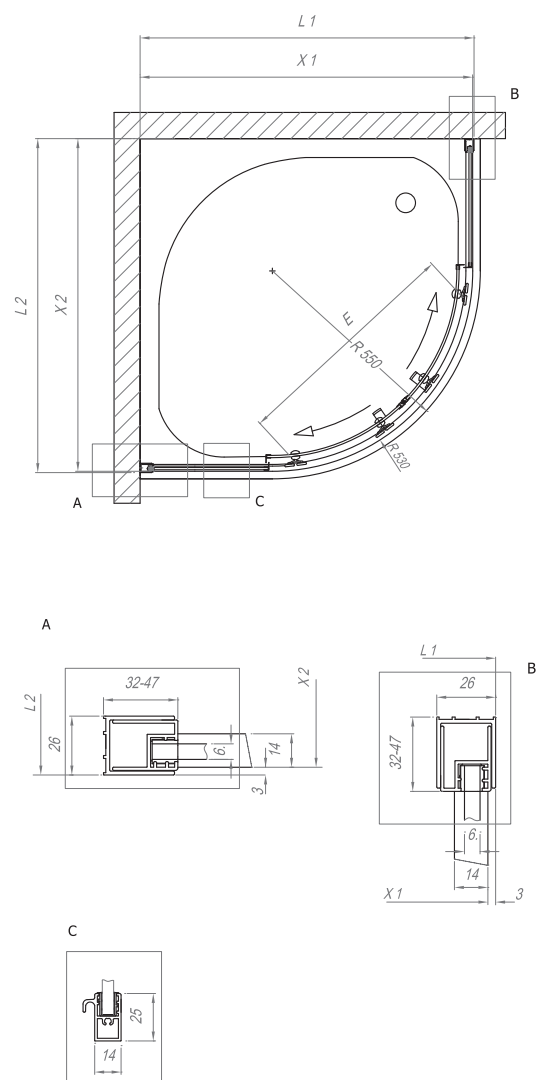

Lavolta R, Moonwalk R, Macarena, Drop R, Malur, Dixie, Evelin Tray R, Ontex.

Pulsar TKP 100, 90

Pulsar			L1	L2	X1	X2			E	
TKP 100			985 - 995	985 - 995	982 - 992	982 - 992	550	2000	510	
TKP 90			885 - 895	885 - 895	882 - 892	882 - 892	550	2000	495	

Pulsar TV2D/s 120, 100

188

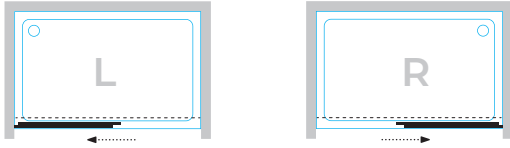

TV2D/s 120, 100

- Samostojna tuš vrata, enostransko odpiranje.
- Self-supporting shower door, single-side opening.
- Samostalna tuš vrata, jednostrano otvaranje.
- Samostoječa tuš vrata, jednostrano otvaranje.

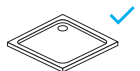
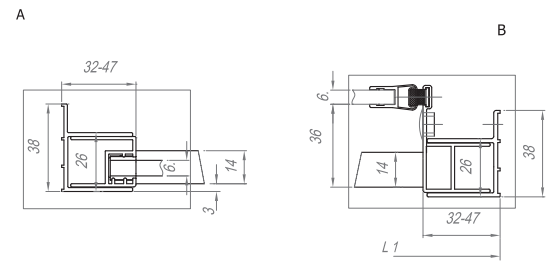
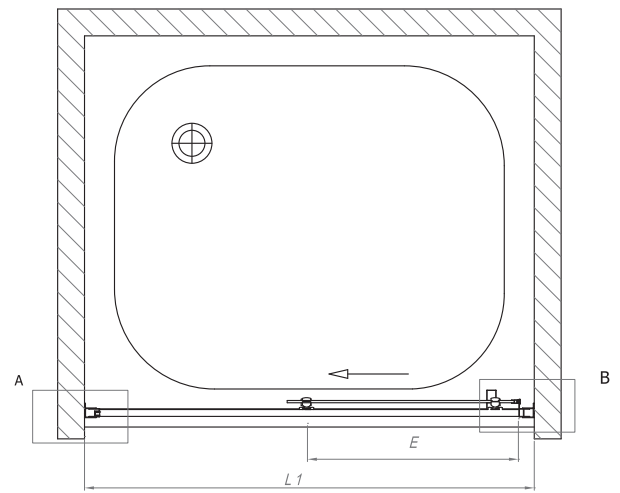

Ballo, Tello, Lavolta, Lerock zero, Ramona tray, Moonwalk, Limbo, Re-walk, Capo, Acro, Pandora Tray, Canary, Serra, Drop, Flamenco, Funky, Evelin Tray Q.

Pulsar			L1	L2	X1	X2		E	
TV2D/S 120 - L, D			1175 - 1200				2000	510	
TV2D/S 100 - L, D			975 - 1000				2000	410	

Pulsar TV2D/s 120, 100 - L, D + TS 90, 80

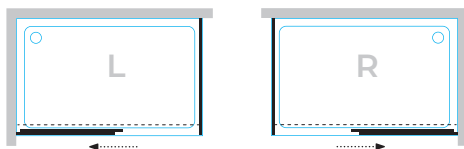

TV2D/s 120, 100 - L, D + TS 90, 80

- Tuš kabina - vrata in stena, levo ali desno enostransko odpiranje.
- Shower enclosure - door and wall, left or right-side opening.
- Tuš kabina - vrata i stijena, lijevo ili desno jednostrano otvaranje.
- Tuš kabina - vrata i zid, levo ili desno jednostrano otvaranje.

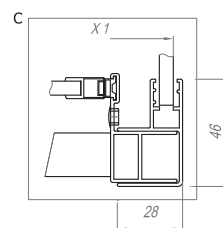
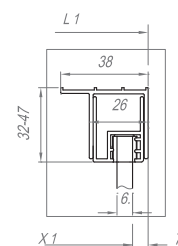
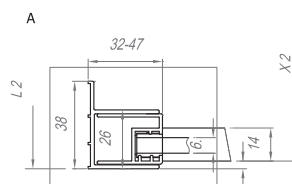
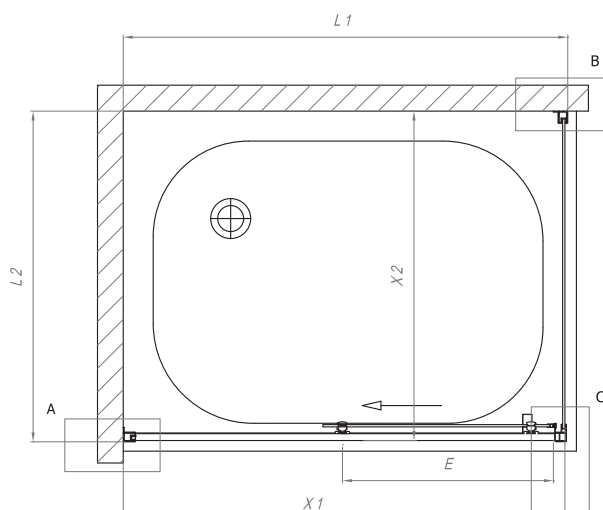
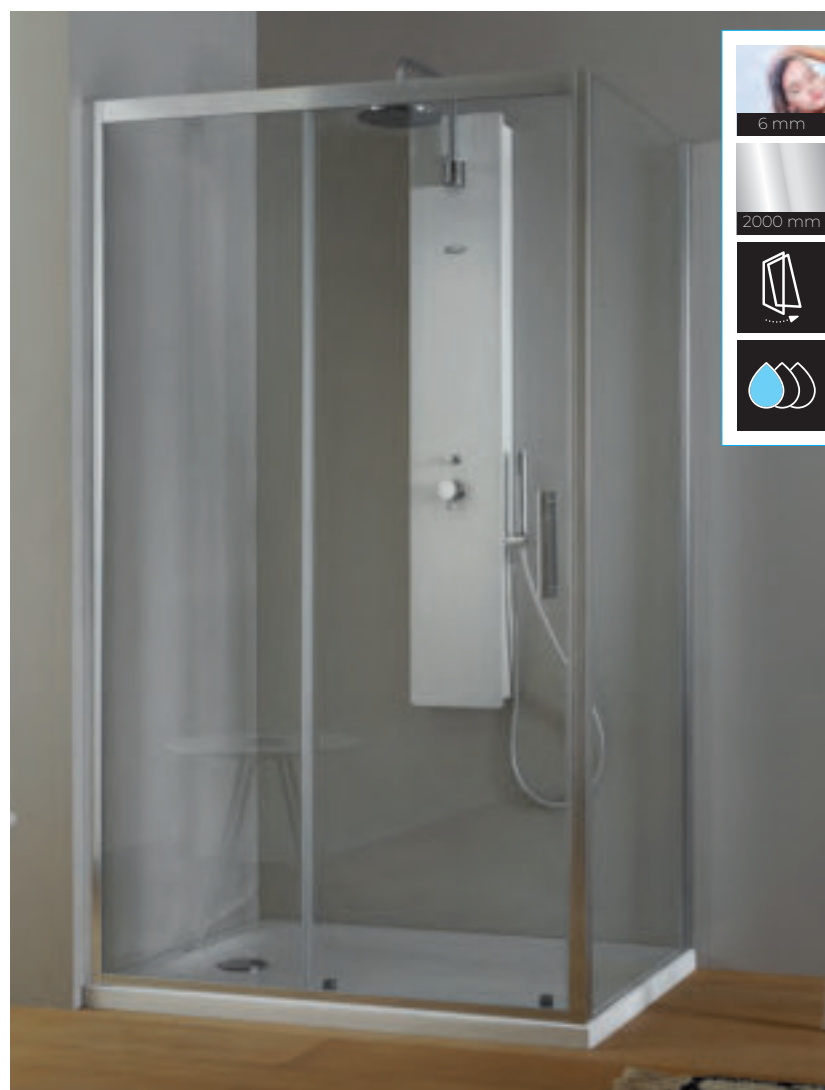

Ballo, Tello, Lavolta, Lerock zero, Ramona tray, Moonwalk, Limbo, Re-walk, Capo, Acro, Pandora Tray, Canary, Serra, Drop, Flamenco, Funky, Evelin Tray Q.

Pulsar			L1	L2	X1	X2		E	
TV2D/S 120 - L, D			1175 - 1190		1168 - 1183		2000	510	
TV2D/S 100 - L, D			975 - 900		968 - 983		2000	410	
TS 90				875 - 890		872 - 887	2000		
TS 80				775 - 790		772 - 787	2000		

Dodatni profili

Additional profiles

Dodatni profili

Dodatni profili

190





Različica z dodatnim profilom K 25 za TKK, TKP, TV in TS.

Version with the compensational profile K 25 for TKK, TKP, TV and TS.

Varijanta s dodatnim profilom K 25 za TKK, TKP TV i TS.

Varijanta sa dodatnim profilom K 25 za TKK, TKP, TV i TS.



Tip / Type	Vrsta profila / Type of profile		
K 25 Pulsar <div style="display: inline-block; width: 20px; height: 10px; background-color: #ccc; margin: 0 5px;"></div> <div style="display: inline-block; width: 20px; height: 10px; background-color: #eee; margin: 0 5px;"></div>	dodatni profil za TKK, TKP, TV, TS Pulsar additional profile for TKK, TKP, TV2D, TV4D, TS SQ line	2000	25







SQ Line

SQ LINE



 <p>5/6 mm</p>	<p>5/6 mm kaljeno prozorno steklo 5/6 mm transparent tempered glass 5/6 mm kaljeno prozirno staklo 5/6 mm prozirno kaljeno staklo</p>	 
 <p>5/6 mm</p>	<p>5/6 mm chinchilla kaljeno steklo 5/6 mm chinchilla tempered glass 5/6 mm chinchilla kaljeno staklo 5/6 mm chinchilla kaljeno staklo</p>	 
 <p>1900 mm 1600 mm</p>	<p>Silver profili (srebrna galvanska prevleka) Silver Studs (silver galvanised coating) Silver profili (srebrna galvanska prevlaka) Silver profili (srebrni galvanski premaz)</p>	 
 <p>1900 mm 1600 mm</p>	<p>Beli profili (prašno lakiranje) White Studs (powder coating) Beli profili (lakiranje raspršivanjem) Fehér profilok (porlakkozás)</p>	 
	<p>zapiranje z magnetnim profilom magnetic edge closure zatvaranje s magnetskim profilom zatvaranje pomoću magnetnog profila</p>	
	<p>možnost kompenzacijskih profilov the possibility of compensation profiles mogućnost kompenzacijskih profila mogućnost kompenzacionih profila</p>	
	<p>snemljiva vratna krila omogočajo lažje čiščenje detachable door panels for easy cleaning vratna krila na skidanje omogočuju lakše čiščenje vratna krila sa mogućnošću skidanja omogućavaju lakše čiščenje</p>	



SQ line TKK 120, 100, 90, 80, 70

194

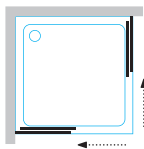

TKK 120, 100, 90, 80, 70

- **Kotna tuš kabina.** Snemljivi vratni krila na krogličnih ležajih, ki omogočajo lažje čiščenje.
- **Corner shower enclosure.** Door panels on ball bearings, detachable for easier cleaning.
- **Kutna tuš kabina.** Vratna krila na kugličnim ležajevima koja se mogu skidati i tako omogućavaju lakše čišćenje.
- **Četrtasta tuš kabina.** Krila sa mogućnošću skidanja na kugličnim ležajevima koja omogućavaju lakše čišćenje.

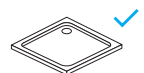
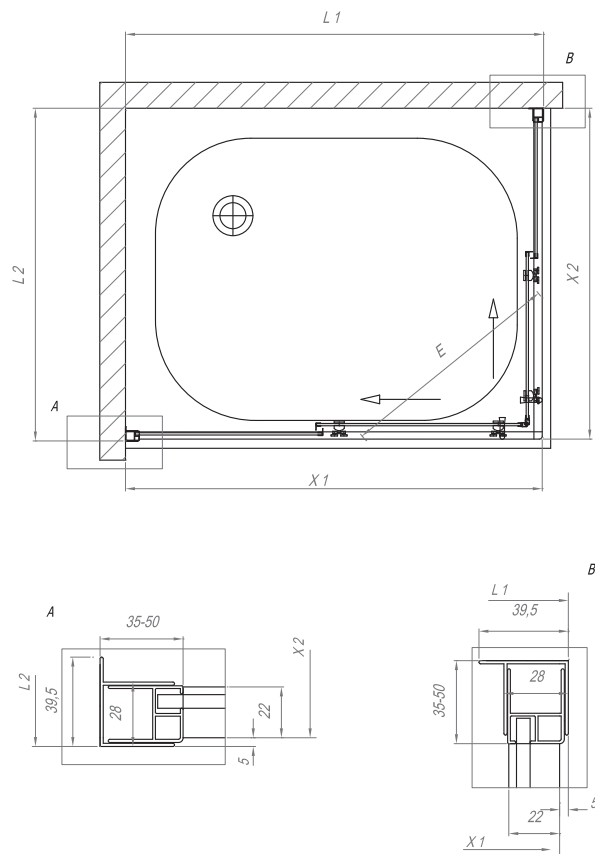

Tello, Lavolta, Lerock zero, Ramona tray, Moonwalk, Funky, Limbo, Re-walk, Capo, Acro, Pandora Tray, Canary, Serra, Drop, Flamenco, Evelin Tray Q, Trin.

SQ line			L1	L2	X1	X2		E	
TKK 120x90			1180 - 1195	880 - 895	1175 - 1190	875 - 890	1900	590	
TKK 120x80			1180 - 1195	780 - 795	1175 - 1190	775 - 790	1900	565	
TKK 100x90			980 - 995	880 - 895	975 - 990	875 - 890	1900	560	
TKK 100x80			980 - 995	780 - 795	975 - 990	775 - 790	1900	500	
TKK 90x80			880 - 895	780 - 795	875 - 890	775 - 790	1900	480	
TKK 90x75			880 - 895	730 - 745	875 - 890	725 - 740	1900	450	
TKK 90x70			880 - 895	680 - 695	875 - 890	675 - 690	1900	420	
TKK 100			980 - 995	980 - 995	975 - 990	975 - 990	1900	580	
TKK 90			880 - 895	880 - 895	875 - 890	875 - 890	1900	480	
TKK 80			780 - 795	780 - 795	775 - 790	775 - 790	1900	420	
TKK 70			680 - 695	680 - 695	675 - 690	675 - 690	1900	370	

SQ line TKP 120, 100, 90, 80

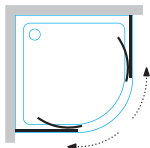

TKP 120, 100, 90, 80

- Polkrožna tuš kabina. Snemljivi vratni krili na krogličnih ležajih, ki omogočajo lažje čiščenje.
- Semi-circular shower enclosure. Door panels on ball bearings, detachable for easier cleaning.
- Polukružna tuš kabina. Vratna krila na kugličnim ležajevima koja se mogu skidati i tako omogućavaju lakše čišćenje.
- Polukružna tuš kabina. Krila sa mogućnošću skidanja na kugličnim ležajevima koja omogućavaju lakše čišćenje.

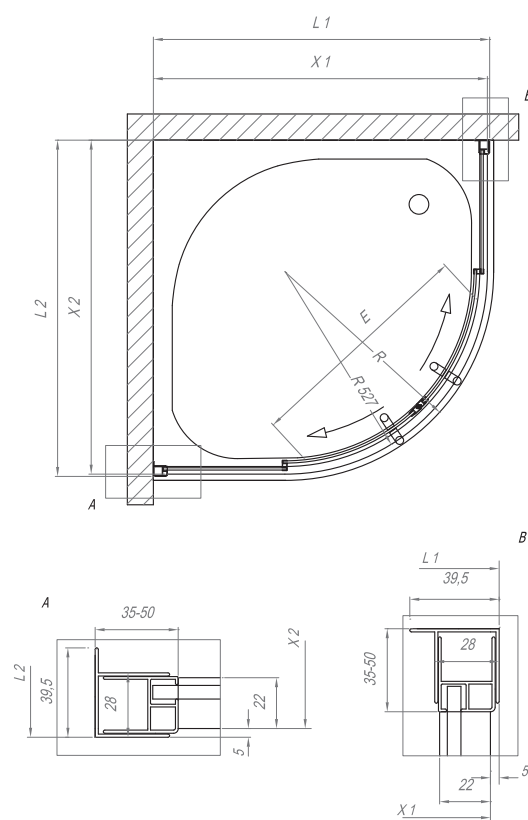
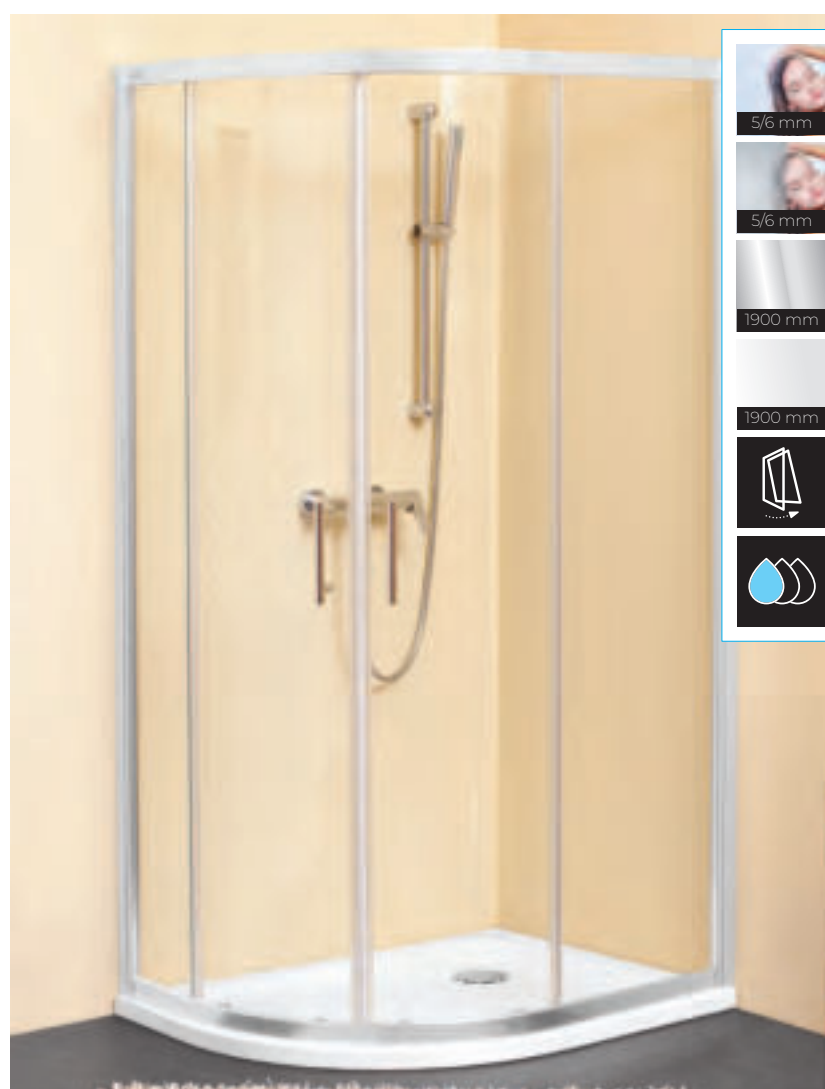

Lavolta R, Moonwalk R, Macarena, Drop R, Malur, Dixie, Evelin Tray R, Ontex.

SQ line				L1	L2	X1	X2			E	
TKP 120x90				1180 - 1195	880 - 895	1175 - 1190	875 - 890	550	1900	530	
TKP 100x80				980 - 995	780 - 795	975 - 990	775 - 790	550	1900	490	
TKP 100				980 - 995	980 - 995	975 - 990	975 - 990	550	1900	520	
TKP 90				880 - 895	880 - 895	875 - 890	875 - 890	550	1900	520	
TKP 80				780 - 795	780 - 795	775 - 790	775 - 790	550	1900	420	

SQ line TV2D/S 130, 120, 110, 100

196

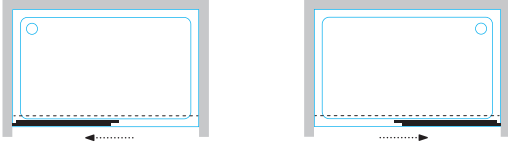

TV2D/S 130, 120, 110, 100

- **Dvodielna tuš vrata.** Leva ali desna različica z obračanjem vrat ali stene. Snemljivi vratni krila na krogličnih ležajih, ki omogočajo lažje čiščenje.
- **Two-piece shower door.** Door panels on ball bearings, detachable for easier cleaning. Left or right hand versions.
- **Dvodielna tuš-vrata.** Lijeva ili desna verzija s okretanjem vrata ili stijene. Vratna krila na kugličnim ležajevima koja se mogu skidati i tako omogućavaju lakše čišćenje.
- **Dvodielna tuš vrata.** Leva ili desna varijanta sa okretanjem vrata ili zida. Krila sa mogućnošću skidanja na kugličnim ležajevima koja omogućavaju lakše čišćenje.

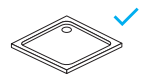
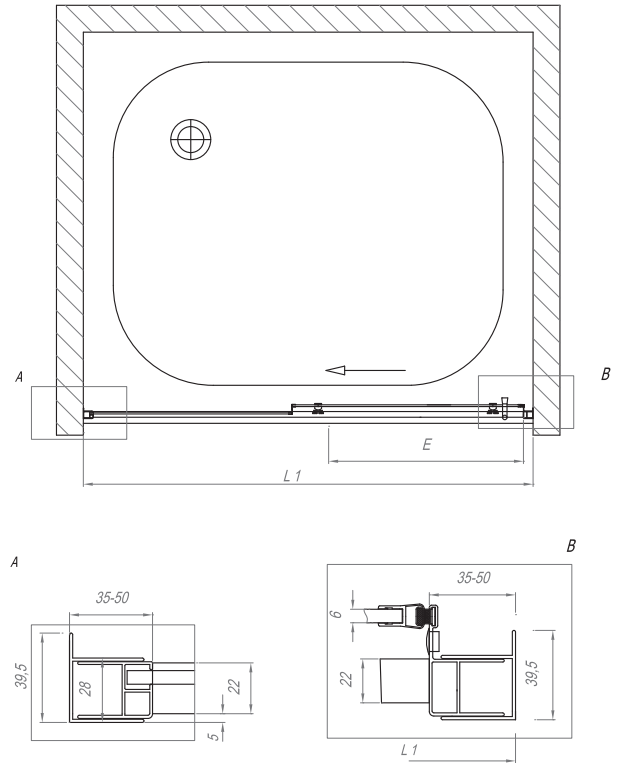
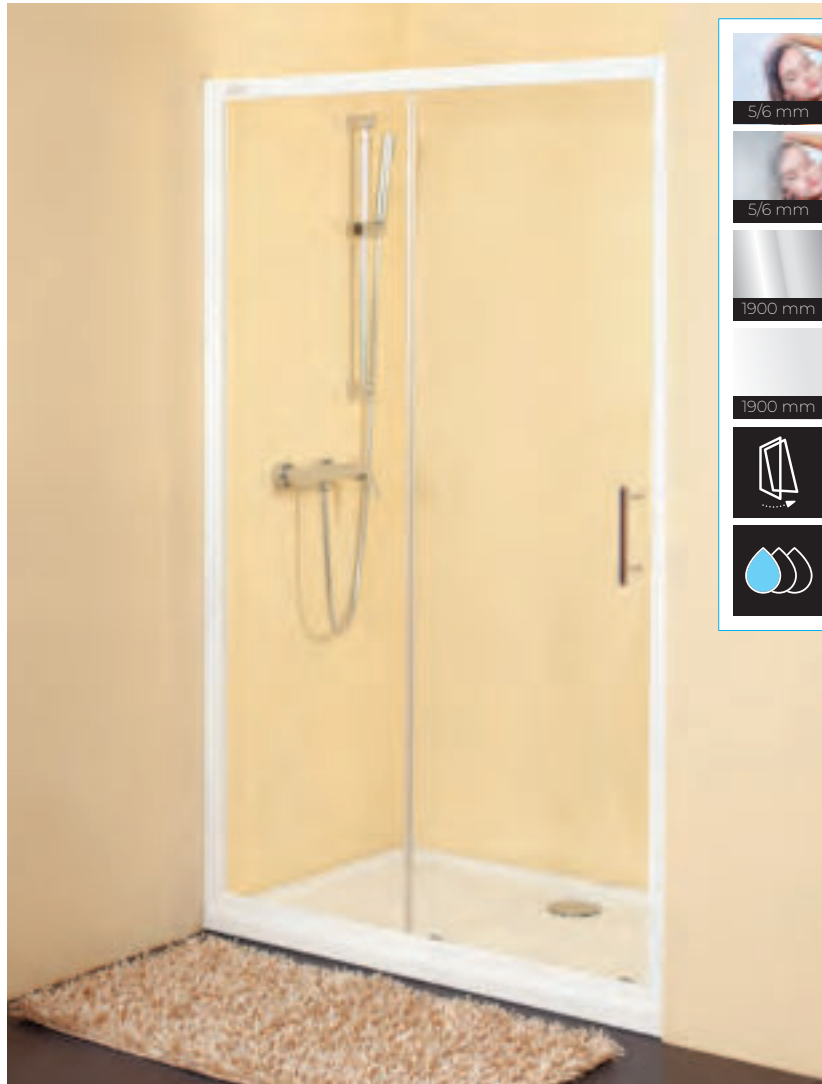

Tello, Lavolta, Lerock zero, Ramona tray, Moonwalk, Stiletto, Limbo, Re-walk, Capo, Acro, Pandora Tray, Canary, Serra, Drop, Flamenco, Funky, Evelin Tray Q.

SQ line			L1	L2	X1	X2		E	
TV2D/S 130			1275 - 1300				1900	520	
TV2D/S 120			1175 - 1200				1900	510	
TV2D/S 110			1075 - 1100				1900	480	
TV2D/S 100			975 - 1000				1900	410	

SQ line TV2D/S + TS 90, 80, 75, 70

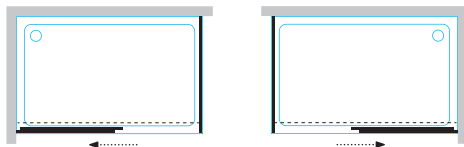

TV2D/S + TS 90, 80, 75, 70

- **Dvodielna tuš vrata s tuš steno.** Leva ali desna različica z obračanjem vrat ali stene. Snemljivi vratni krili na krogličnih ležajih, ki omogočajo lažje čiščenje.
- **Two-piece shower door with shower wall.** Door panels on ball bearings, detachable for easier cleaning. Left or right hand versions.
- **Dvodielna tuš-vrata s tuš-stijenom.** Lijeva ili desna verzija s okretanjem vrata ili stijene. Vratna krila na kugličnim ležajevima koja se mogu skidati i tako omogućavaju lakše čišćenje.
- **Dvodielna tuš vrata sa tuš zidom.** Leva ili desna varijanta sa okretanjem vrata ili zida. Krila sa mogućnošću skidanja na kugličnim ležajevima koja omogućavaju lakše čišćenje.

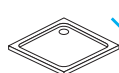
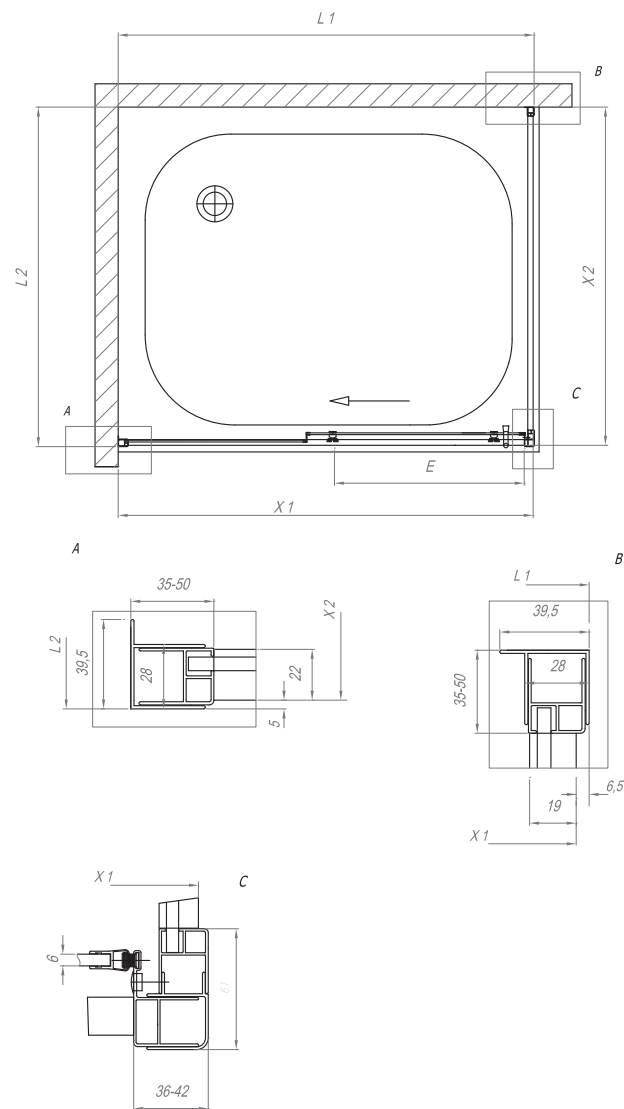

Tello, Lavolta, Lerock zero, Ramona tray, Moonwalk, Stiletto, Limbo, Re-walk, Capo, Acro, Pandora Tray, Canary, Serra, Drop, Flamenco, Funky, Evelin Tray Q.

SQ line			L1	L2	X1	X2		E	
TV2D/S 130			1275 - 1300		1268 - 1293		1900	520	
TV2D/S 120			1175 - 1200		1168 - 1193		1900	510	
TV2D/S 110			1075 - 1100		1068 - 1093		1900	480	
TV2D/S 100			975 - 1000		968 - 993		1900	410	
TS 90				880 - 895		875 - 890	1900		
TS 80				780 - 795		775 - 790	1900		
TS 75				730 - 745		725 - 740	1900		
TS 70				680 - 695		675 - 690	1900		

SQ line TV2D/S + 2xTS 90, 80, 75, 70

198

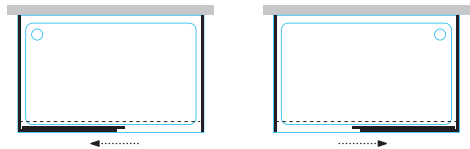

TV2D/S + 2xTS 90, 80, 75, 70

- **Dvodielna tuš vrata z dvema tuš stenama.** Leva ali desna različica z obračanjem vrat ali stene. Snemljivi vratni krili na krogličnih ležajih, ki omogočajo lažje čiščenje.
- **Two-part shower door with two shower walls.** Door panels on ball bearings, detachable for easier cleaning. Left or right hand versions.
- **Dvodielna tuš vrata s dvije tuš stijene.** Lijevo ili desno verzija s okretanjem vrata ili stijene. Vratna krila na kugličnim ležajevima koja se mogu skidati i tako omogućavaju lakše čišćenje.
- **Dvodielna tuš vrata sa dva tuš stuba.** Leva ili desna varijanta sa okretanjem vrata ili zida. Krila sa mogućnošću skidanja na kugličnim ležajevima koja omogućavaju lakše čišćenje.

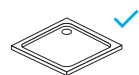
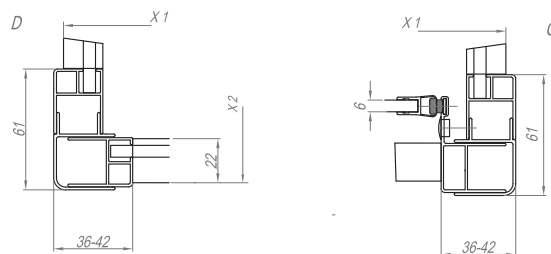
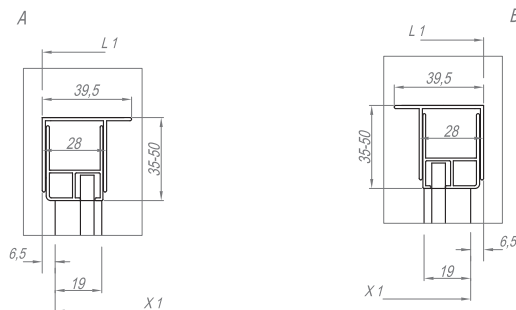
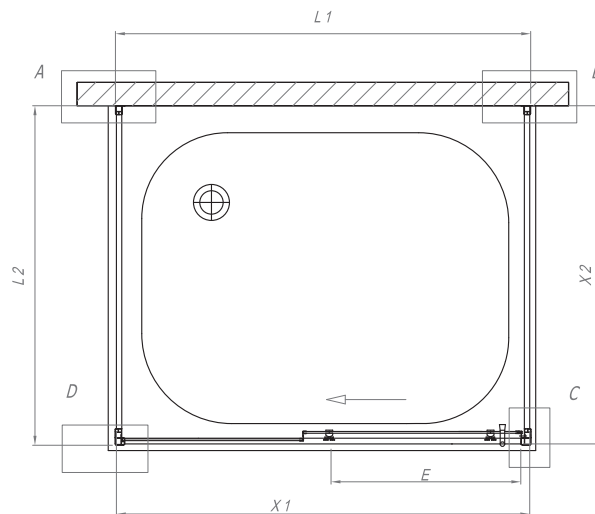

Tello, Lavolta, Lerock zero, Ramona tray, Moonwalk, Stiletto, Limbo, Re-walk, Capo, Acro, Pandora Tray, Canary, Serra, Drop, Flamenco, Funky, Evelin Tray Q.

SQ line			L1	L2	X1	X2		E	
TV2D/S 130			1275 - 1300		1268 - 1293		1900	520	
TV2D/S 120			1175 - 1200		1168 - 1193		1900	510	
TV2D/S 110			1075 - 1100		1068 - 1093		1900	480	
TV2D/S 100			975 - 1000		968 - 993		1900	410	
TS 90				880 - 895		875 - 890	1900		
TS 80				780 - 795		775 - 790	1900		
TS 75				730 - 745		725 - 740	1900		
TS 70				680 - 695		675 - 690	1900		

SQ line TV4D/S 170, 160, 140

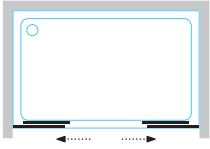

TV4D/S 170, 160, 140

- **Samostojna tuš vrata s sredinskim odpiranjem.**
Snemljivi vratni krili na krogličnih ležajjih, ki omogočajo lažje čiščenje.
- **Shower door with central position.**
Door panels on ball bearings, detachable for easier cleaning.
- **Samostalna tuš vrata sa središnjim otvaranjem.**
Vratna krila na kugličnim ležajevima koja se mogu skidati i tako omogućavaju lakše čišćenje.
- **Tuš vrata sa centralnim otvaranjem.**
Krila sa mogućnošću skidanja na kugličnim ležajevima koja omogućavaju lakše čišćenje.

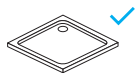
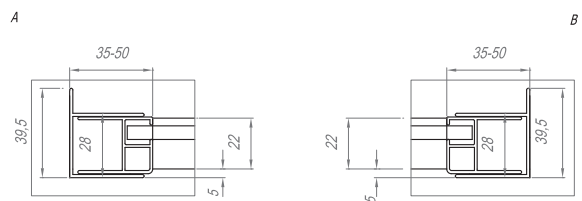
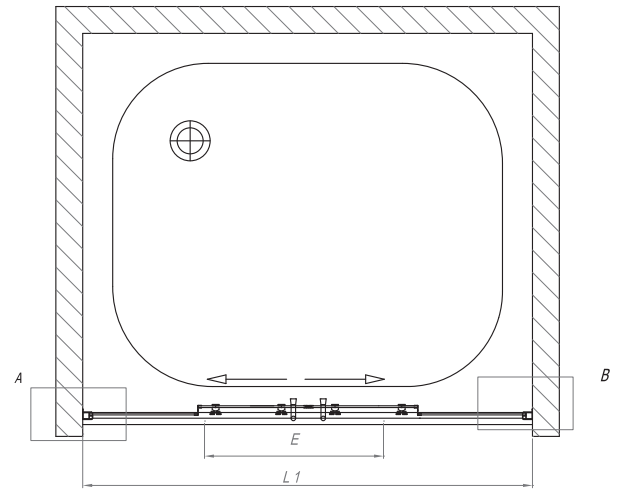
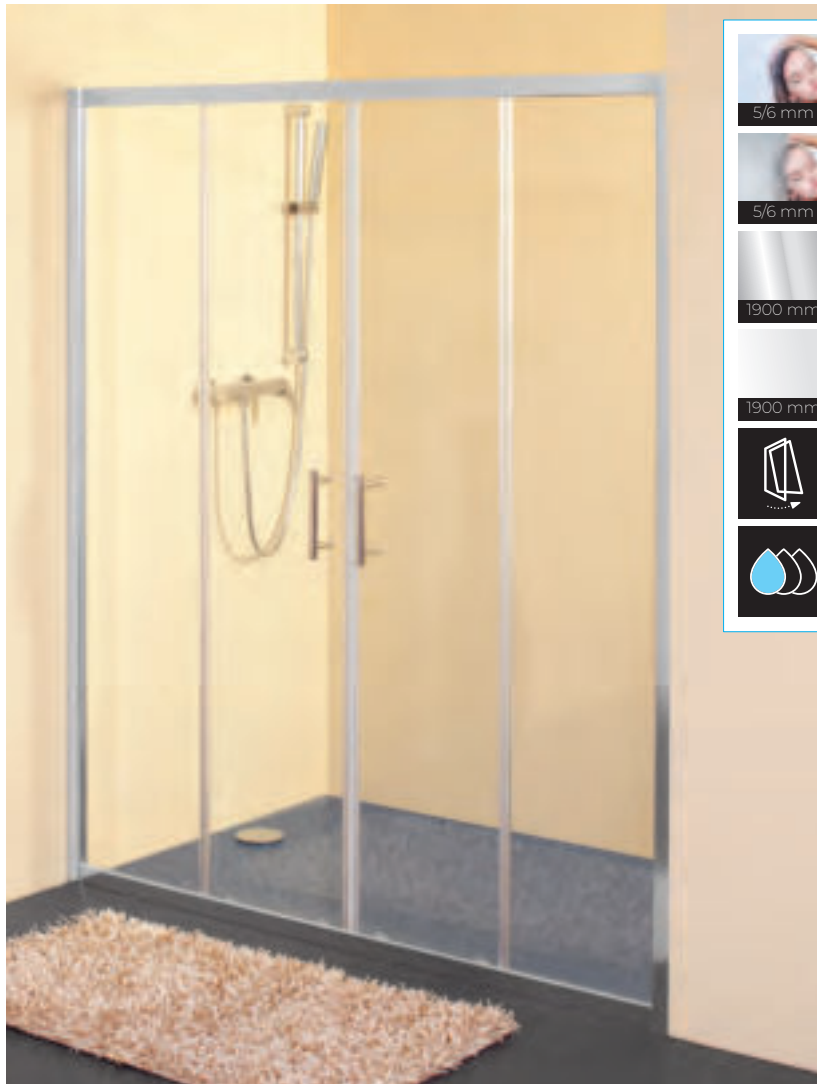

Ballo, Tello, Lavolta, Moonwalk, Limbo, Re-walk, Capo, Acro, Canary, Serra, Drop, Flamenco.

SQ line			L1	L2	X1	X2		E	
TV4D/S 170			1675 - 1700				1900	715	
TV4D/S 160			1575 - 1600				1900	630	
TV4D/S 140			1375 - 1400				1900	590	

SQ line TV4D/S + TS 90, 80, 75, 70

200

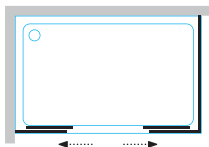

TV4D/S + TS 90, 80, 75, 70







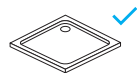
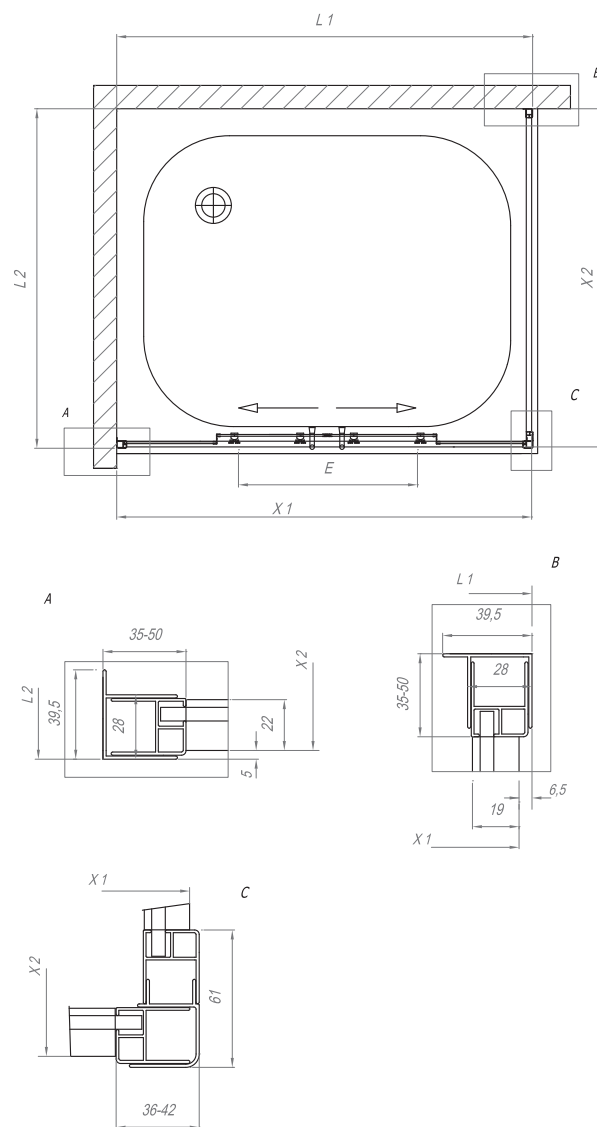























- **Samostojna tuš vrata s sredinskim odpiranjem s tuš steno.**
Snemljivi vratni krili na krogličnih ležajih, ki omogočajo lažje čiščenje.
- **Shower door with central position with shower wall.**
Door panels on ball bearings, detachable for easier cleaning.
- **Samostalna tuš vrata sa središnjim otvaranjem s tuš-stijenom.**
Vratna krila na kugličnim ležajevima koja se mogu skidati i tako omogućavaju lakše čišćenje.
- **Tuš vrata sa centralnim otvaranjem sa tuš zidom.**
Krila sa mogućnošću skidanja na kugličnim ležajevima koja omogućavaju lakše čišćenje.



-  5/6 mm
-  5/6 mm
-  1900 mm
-  1900 mm
- 
- 



Tello, Lavolta, Lerock zero, Ramona tray, Moonwalk, Limbo, Re-walk, Capo, Acro, Pandora Tray, Canary, Serra, Drop, Flamenco, Funky, Evelin Tray Q.

SQ line			L1 	L2 	X1 	X2 		E 	
TV4D/S 120			1675 - 1700		1668 - 1693		1900	715	
TV4D/S 110			1575 - 1600		1568 - 1593		1900	630	
TV4D/S 100			1375 - 1400		1368 - 1393		1900	590	
TS 90				880 - 895		875 - 890	1900		
TS 80				780 - 795		775 - 790	1900		
TS 75				730 - 745		725 - 740	1900		
TS 70				680 - 695		675 - 690	1900		

SQ line TV4D/S + TS 90, 80, 75, 70

SQ line Tkp 90 Dixie

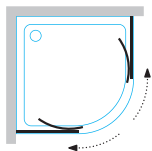

201



TKP 90 Dixie

- Polkrožna tuš kabina za tuš kad Dixie.
Snemljivi vratni krili na krogličnih ležajih, ki omogočajo lažje čiščenje, h=160.
- Semi-circular shower enclosure for the Dixie shower tray.
Door panels on ball bearings, detachable for easier cleaning, h=160.
- Polukružna tuš kabina za tuš kado Dixie.
Vratna krila na skidanje na kugličnim ležajevima koji omogućuju lakše čiščenje, h=160.
- Polukružna tuš kabina za tuš kado Dixie.
Dixie. Krila sa mogućnošću skidanja na kugličnim ležajevima koja omogućavaju lakše čiščenje, h=160.

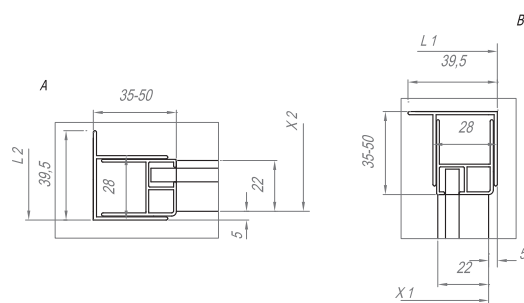
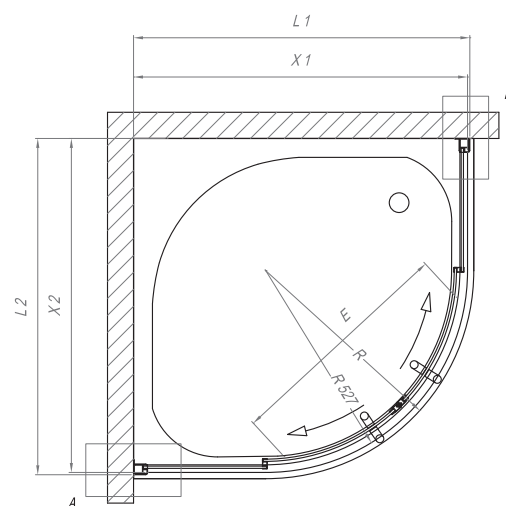

Dixie.

Izdelek je zelo primeren za starejše uporabnike.
The product is well suited for elderly users.
Proizvod je vrlo primjeren za starije korisnike.
Proizvod je veoma adekvatan za starije korisnike.

SQ line

TKP 90/CH Dixie

L1
880 - 895L2
880 - 895X1
875 - 890X2
875 - 890

550

1600

E
520

Dodatni profili

Additional profiles

Dodatni profili

Dodatni profili

Različica z dodatnim profilom K 30
za TKK, TKP, TV2D, TV4D, TV in TS.

Version with the compensational profile
K 30 for TKK, TKP, TV2D, TV4D, TV and TS.

Varijanta s dodatnim profilom K 30
za TKK, TKP, TV2D, TV4D, TV i TS.

Varijanta sa dodatnim profilom K 30
za TKK, TKP, TV2D, TV4D, TV i TS.

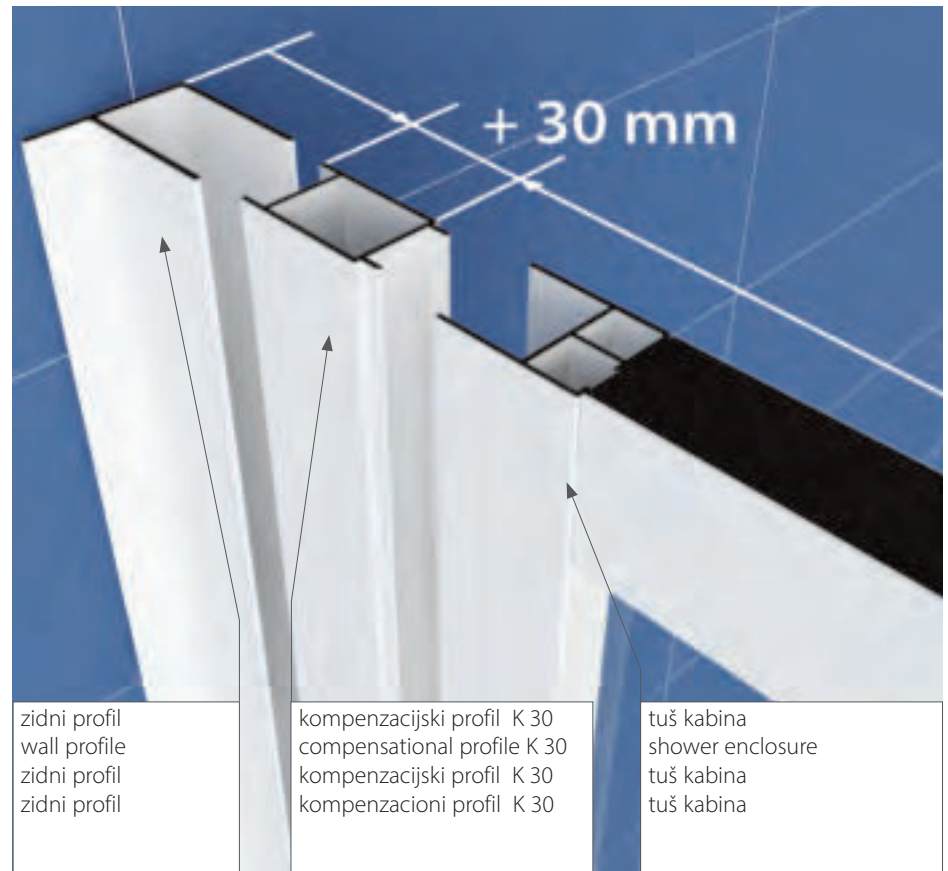

Tip/Type

Vrsta profila /
Type of profile



K 30 SQ line



dodatni profil za TKK, TKP, TV2D, TV4D, TV in TS SQ line
additional profile for TKK, TKP, TV2D, TV4D, TV and TS SQ line

1900

30













204

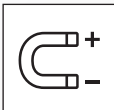

Luna

LUNA

 <p>4/6 mm</p>	<p>4/6 mm kaljeno prozorno steklo 4/6 mm transparent tempered glass 4/6 mm kaljeno prozirno staklo 4/6 mm prozirno kaljeno staklo</p>	 
<p>1900 mm 1850 mm</p>	<p>Silver profili (srebrna galvanska prevleka) Silver Studs (silver galvanised coating) Silver profili (srebrna galvanska prevlaka) Silver profili (srebrni galvanski premaz)</p>	 
	<p>zapiranje z magnetnim profilom magnetic edge closure zatvaranje s magnetnim profilom zatvaranje pomoću magnetnog profila</p>	
	<p>možnost kompenzacijskega profila K 30 – za TV3D/S, TVZ/S optional compensation studs K 30 for TV3D/S, TVZ/S mogućnost kompenzacijskog profila K 30 – za TV3D/S, TVZ/S mogućnost kompenzatornog profila K 30 – za TV3D/S, TVZ/S</p>	
	<p>možnost kompenzacijskega profila K 25 – za TVO/S optional compensation studs K 25 for TVO/S mogućnost kompenzacijskog profila K 25 – za TVO/S mogućnost kompenzatornog profila K 25 – za TVO/S</p>	

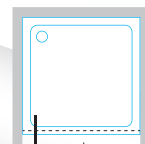
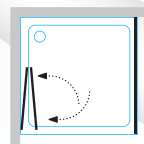
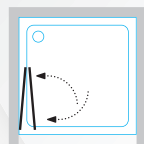
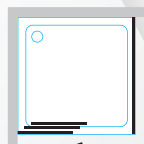
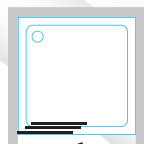

Luna TV3D/S 100, 90, 80

206

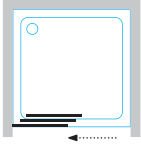

TV3D/S 100, 90, 80

- **Samostojna tuš vrata, tridelna.** Možnost vgradnje dodatnega profila K 30 za izvedbo nestandardnih dimenzij kabin po širini.
- **Freestanding shower cabin, threefold.** Optional K 30 profile for non-standard cabin widths.
- **Samostalna tuš vrata, tridelna.** Mogućnost ugradnje dodatnog profila K 30 za izvedbu nestandardnih dimenzija kabina po širini.
- **Samostalna tuš vrata, tridelna.** Mogućnost ugradnje dodatnog profila K 30 za izvođenje nestandardnih dimenzija kabina po širini.

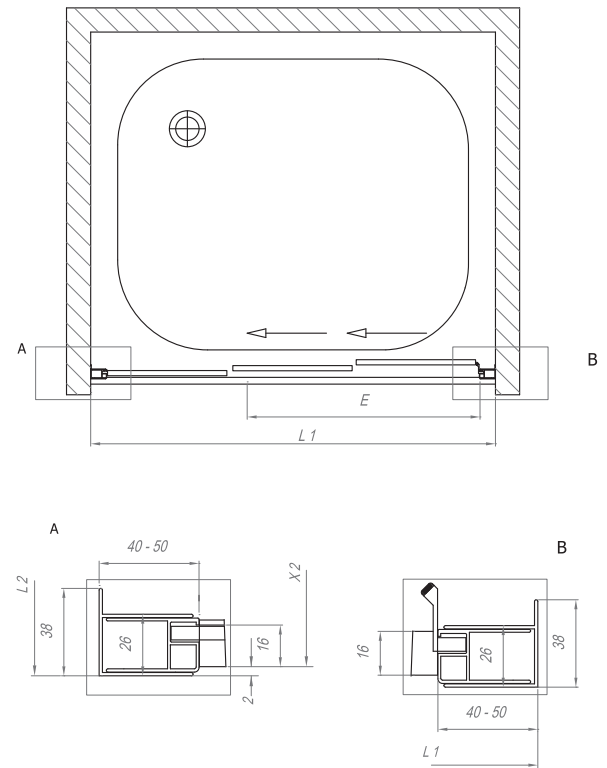

Luna TV3D/S 100, 90, 80

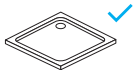

Tello, Lavolta, Lerock zero, Ramona tray, Moonwalk, Stiletto, Limbo, Re-walk, Capo, Acro, Pandora Tray, Canary, Serra, Drop, Flamenco, Funky, Evelin Tray Q.

Luna			L1	L2	X1	X2		E	
TV3D/S 100			980 - 1000				1850	500	
TV3D/S 90			880 - 900				1850	430	
TV3D/S 80			780 - 800				1850	370	

Luna TV3D/S + TSv3D 90, 80

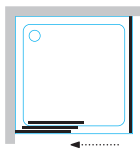

TV3D/S + TSv3D 90, 80

- **Samostojna tuš vrata, tridelna, s tuš steno.** Možnost vgradnje dodatnega profila K 30 za izvedbo nestandardnih dimenzij kabin po širini.
- **Freestanding shower cabin, threefold with shower wall.** Optional K 30 profile for non-standard cabin widths.
- **Samostalna tuš vrata, tridelna.** Mogućnost ugradnje dodatnog profila K 30 za izvedbu nestandardnih dimenzija kabina po širini.
- **Samostalna tuš vrata, tridelna s tuš-stijenom sa tuš zidom.** Mogućnost ugradnje dodatnog profila K 30 za izvođenje nestandardnih dimenzija kabina po širini.

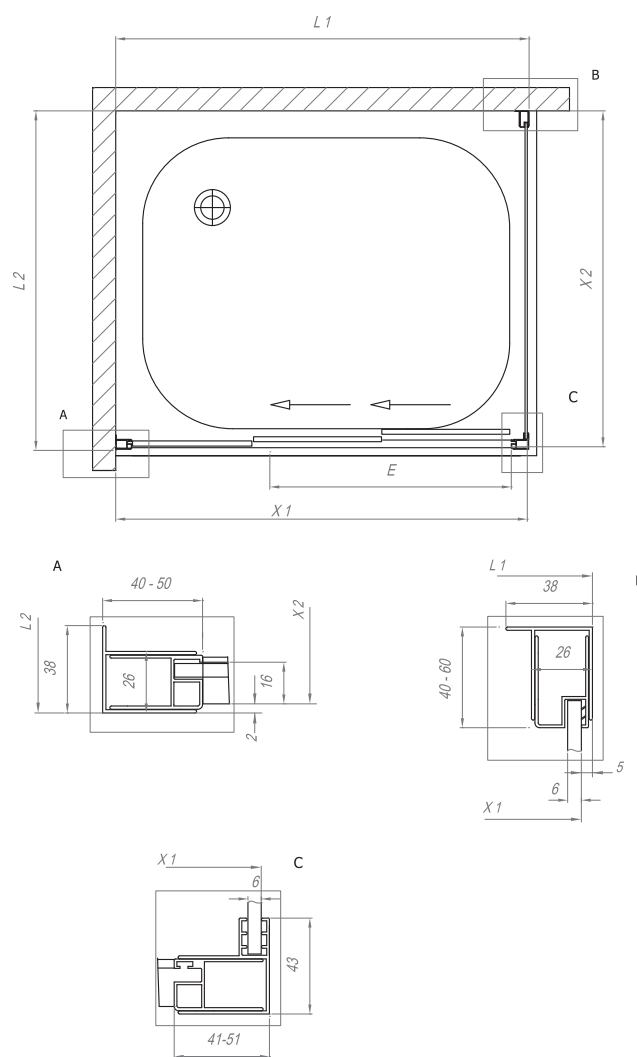

Luna TV3D/S + TSv3D 90, 80

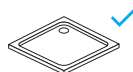

Tello, Lavolta, Lerock zero, Moonwalk, Acro, Pandora Tray, Canary, Serra, Drop, Flamenco, Funky, Evelin Tray Q.

Luna			L1	L2	X1	X2		E	
TV3D/S 100			980 - 1000		975 - 995		1850	500	
TV3D/S 90			880 - 900		875 - 895		1850	430	
TV3D/S 80			780 - 800		775 - 795		1850	370	
TSv3D 90				875 - 895		873 - 893	1850		
TSv3D 80				775 - 795		773 - 793	1850		

Luna TVZ/S 90, 80

208

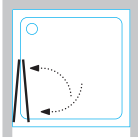

TVZ/S 90, 80

- **Samostojna tuš vrata z zložljivima kriloma.** Možnost vgradnje dodatnega profila K 30 za izvedbo nestandardnih dimenzij kabin po širini.
- **Freestanding shower door with foldable wings.** Optional K 30 profile for non-standard cabin widths.
- **Samostalna tuš vrata preklopna.** Mogućnost ugradnje dodatnog profila K 30 za izvedbu nestandardnih dimenzija kabina po širini.
- **Samostalna tuš vrata sa sklopivim krilima.** Mogućnost ugradnje dodatnog profila K 30 za izvođenje nestandardnih dimenzija kabina po širini.

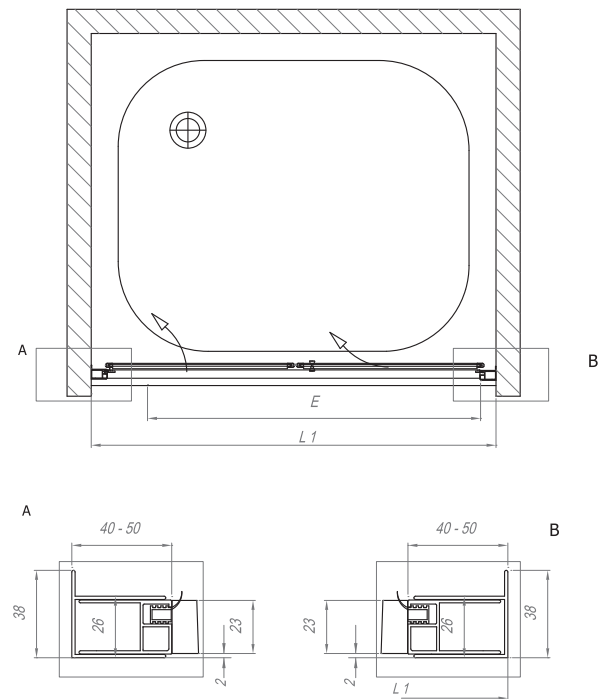

Luna TVZ/S 90, 80

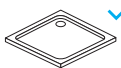

✓ Tello, Lavolta, Lerock zero, Capo, Pandora Tray, Canary, Serra, Drop, Flamenco, Evelin Tray Q., Trin.

Luna			L1	L2	X1	X2		E	
TVZ/S 90			880 - 900				1850	670	
TVZ/S 80			780 - 800				1850	570	

Luna TVZ/S 90, 80 + TSvZ 90, 80

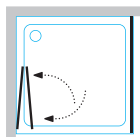

TVZ/S 90, 80 + TSvZ 90, 80

- **Samostojna tuš vrata z zložljivima kriloma s tuš steno.** Možnost vgradnje dodatnega profila K 30 za izvedbo nestandardnih dimenzij kabin po širini.
- **Freestanding shower door with foldable wings with shower wall.** Optional K 30 profile for non-standard cabin widths.
- **Samostalna tuš vrata preklopna s tuš-stijenom.** Mogućnost ugradnje dodatnog profila K 30 za izvedbu nestandardnih dimenzija kabina po širini.
- **Samostalna tuš vrata sa sklopivim krilima sa tuš zidom.** Mogućnost ugradnje dodatnog profila K 30 za izvođenje nestandardnih dimenzija kabina po širini.

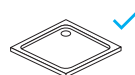
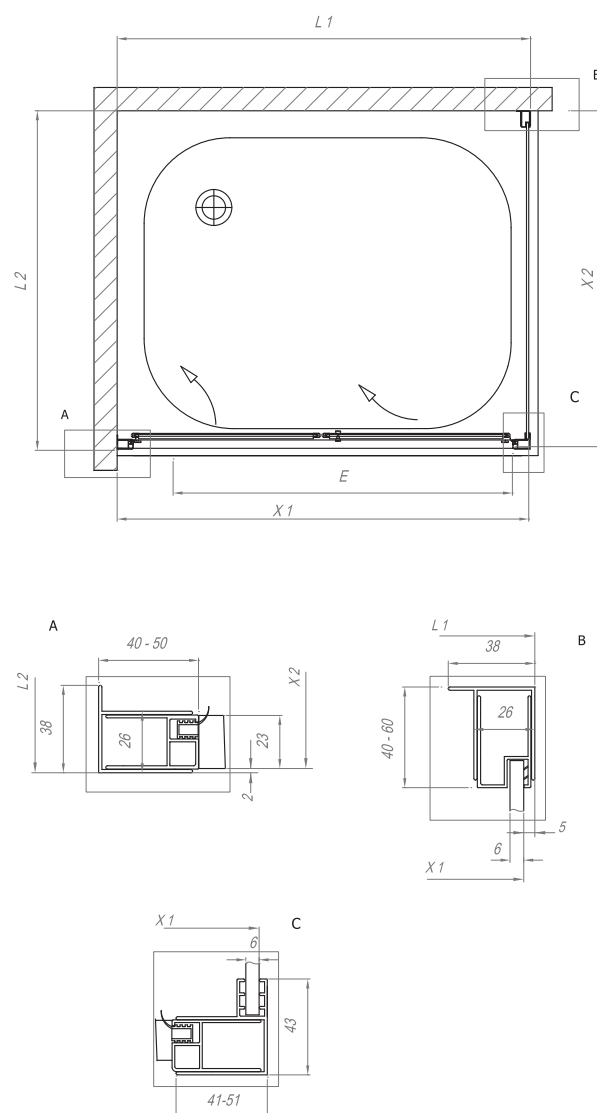

✓ Tello, Lavolta, Lerock zero, Capo, Pandora Tray, Canary, Serra, Drop, Flamenco, Evelin Tray Q., Trin.

Luna			L1	L2	X1	X2		E	
TVZ/S 90			880 - 900				1850	670	
TVZ/S 80			780 - 800				1850	570	
TSvZ 90				875 - 895		873 - 893	1850		
TSvZ 80				775 - 795		773 - 793	1850		

Luna TVO/S 90, 80

210

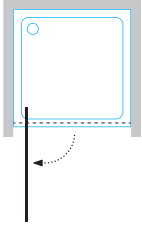

TVO/S 90, 80

- **Samostojna tuš vrata, obračalna.** Možnost vgradnje dodatnega profila K 25 za izvedbo nestandardnih dimenzij kabin po širini.
- **Shower cabin, turnable.** Optional K 25 profile for non-standard cabin widths.
- **Tuš kabina, okretljiva.** Mogućnost ugradnje dodatnog profila K 25 za izvedbu nestandardnih dimenzija kabina po širini.
- **Tuš kabina, okretna.** Mogućnost ugradnje dodatnog profila K 25 za izvedenje nestandardnih dimenzija kabina po širini.

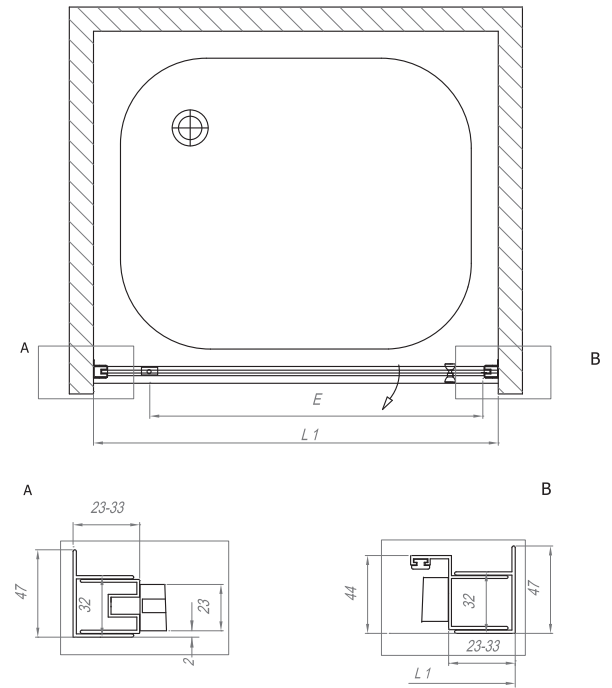

Luna TVO/S 90, 80

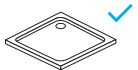

Tello, Lavolta, Lerock zero, Capo, Pandora Tray, Canary, Serra, Drop, Flamenco, Evelin Tray Q., Trin.

Luna			L1	L2	X1	X2		E	
TVO/S 90			880 - 900				1900	630	
TVO/S 80			780 - 800				1900	530	

Dodatni profili

Additional profiles

Dodatni profili

Dodatni profili

Dodatni profil za izvedbo nestandardnih dimenzij kabin po širini.

Različica s kompenzacijskim profilom K 30
– za TV3D/S, TVZ/S

Additional profiles for fitting nonstandard dimension enclosure widths.

The variant with the compensational profile K 30 for TV3D/S, TVZ/S.

Dodatni profil za podešavanje izvan-standardnih dimenzija kabina po širini.

Varijanta s kompenzacijskim profilom K 30
– za TV3D/S, TVZ/S

Dodatni profil za izvedbu nestandardnih dimenzija kabina po širini.

Varijanta sa kompenzacionim profilom K 30
– za TV3D/S, TVZ/S

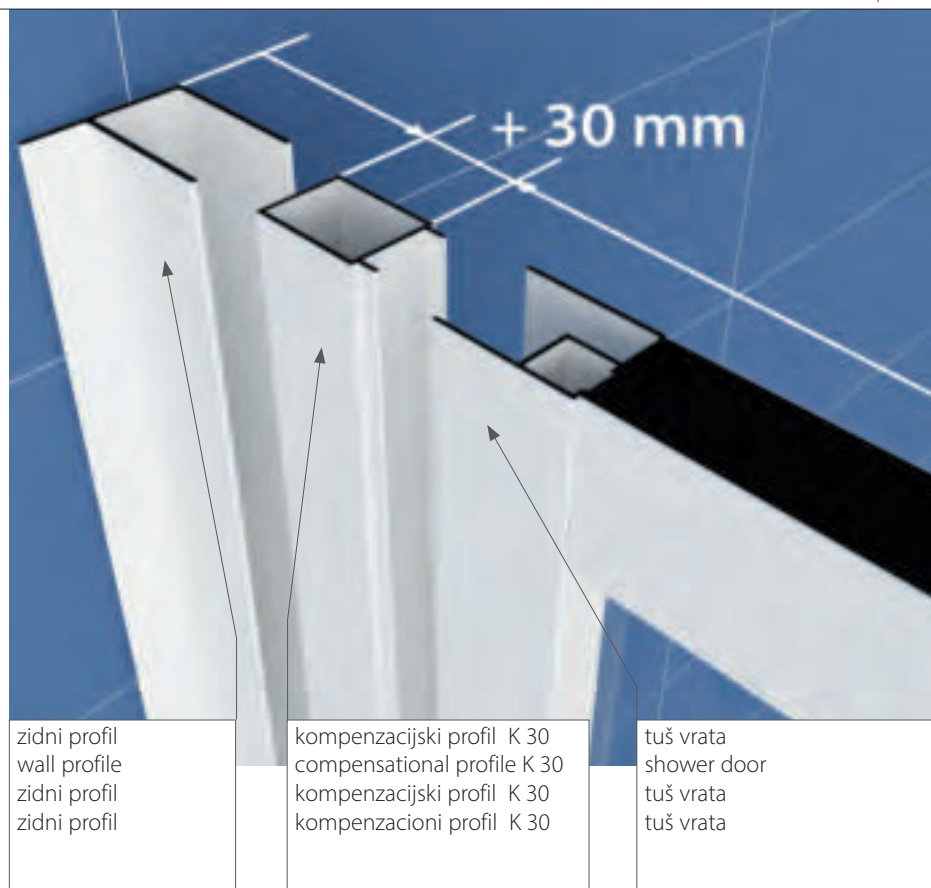

zidni profil
wall profile
zidni profil
zidni profil

kompenzacijski profil K 30
compensational profile K 30
kompenzacijski profil K 30
kompenzacioni profil K 30

tuš vrata
shower door
tuš vrata
tuš vrata

Dodatni profil za izvedbo nestandardnih dimenzij kabin po širini.

Različica s kompenzacijskim profilom K 25
– za TVO/S

Additional profiles for fitting nonstandard dimension enclosure widths.

The variant with the compensational profile K 25 for TVO/S.

Dodatni profil za podešavanje izvan-standardnih dimenzija kabina po širini.

Varijanta s kompenzacijskim profilom K 25
– za TVO/S

Dodatni profil za izvedbu nestandardnih dimenzija kabina po širini.

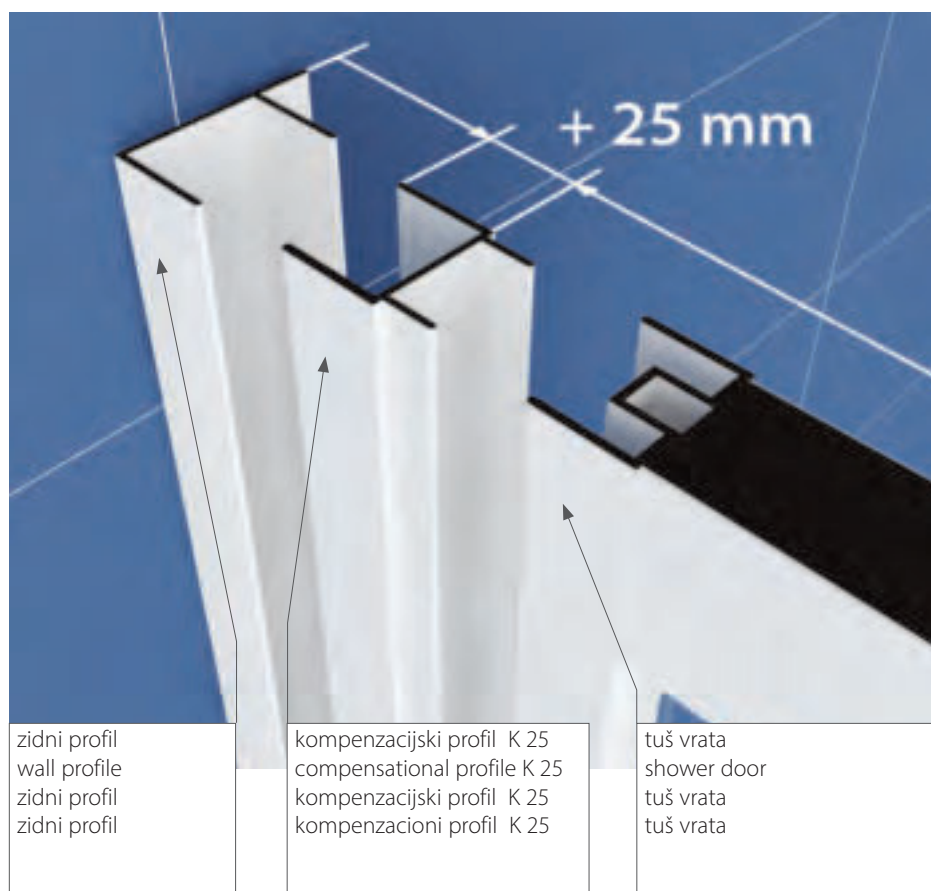

Varijanta sa kompenzacionim profilom K 25
– za TVO/S



zidni profil
wall profile
zidni profil
zidni profil

kompenzacijski profil K 25
compensational profile K 25
kompenzacijski profil K 25
kompenzacioni profil K 25

tuš vrata
shower door
tuš vrata
tuš vrata

Tip/Type	Vrsta profila / Type of profile		
K 30 - TV3D/S, TVZ/S	dodatni profil za TV3D/S, TVZ/S / additional profile for TV3D/S, TVZ/S	1850	30
K 25 - TVO/S	dodatni profil za TVO/S / additional profile for TVO/S	1900	25





Eco Quat

ECO QUAT

	<p>5 mm kaljeno prozorno steklo 5 mm transparent tempered glass 5 mm kaljeno prozirno staklo 5 mm prozirno kaljeno staklo</p>		
5 mm			
	<p>BLACK (črni) profili, prašno lakiranje BLACK profiles, powder coating BLACK (crni) profili, lakiranje prahom BLACK (crni) profili, suvo lakiranje</p>		
	<p>Silver profili (srebrna galvanska prevleka) Silver Studs (silver galvanised coating) Silver profili (srebrna galvanska prevlaka) Silver profili (srebrni galvanski premaz)</p>		
1850 mm			
	<p>zapiranje z magnetnim profilom magnetic edge closure zatvaranje s magnetskim profilom zatvaranje pomoću magnetnog profila</p>		
	<p>snemljiva vratna krila omogočajo lažje čiščenje detachable door panels for easy cleaning vratna krila na skidanje omogočuju lakše čiščenje vratna krila sa mogućnošću skidanja omogućavaju lakše čiščenje</p>		

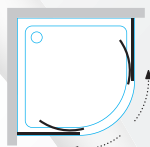
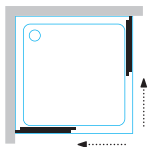

Eco Quat TKK 90, 80

214

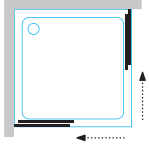

TKK 90, 80

- **Kotna tuš kabina.** Snemljivi vratni krili na krogličnih ležajih, ki omogočajo lažje čiščenje.
- **Corner shower enclosure.** Door panels on ball bearings, detachable for easier cleaning.
- **Kutna tuš kabina.** Vratna krila na kugličnim ležajevima koja se mogu skidati i tako omogućavaju lakše čišćenje.
- **Četrtasta tuš kabina.** Krila sa mogućnošću skidanja na kugličnim ležajevima koja omogućavaju lakše čišćenje.

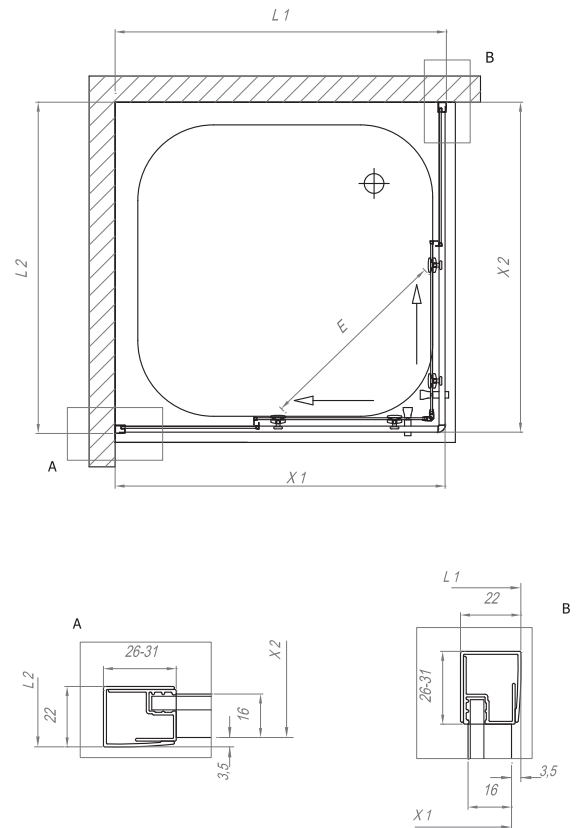

Eco Quat TKK 90, 80

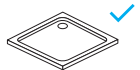

Tello, Lavolta, Lerock zero, Capo, Pandora Tray, Canary, Serra, Drop, Flamenco, Evelin Tray Q., Trin.

Eco Quat			L1	L2	X1	X2		E	
TKK 90			875 - 880	875 - 880	872 - 877	872 - 877	1850	495	
TKK 80			775 - 780	775 - 780	772 - 777	772 - 777	1850	432	

Eco Quat TKP 90, 80

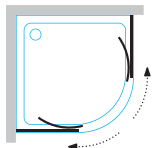

TKP 90, 80

- Polkrožna tuš kabina. Snemljivi vratni krila na krogličnih ležajih, ki omogočajo lažje čiščenje.
- Semi-circular shower enclosure. Door panels on ball bearings, detachable for easier cleaning.
- Polukružna tuš kabina. Vratna krila na kugličnim ležajevima koja se mogu skidati i tako omogućavaju lakše čišćenje.
- Polukružna tuš kabina. Krila sa mogućnošću skidanja na kugličnim ležajevima koja omogućavaju lakše čišćenje.

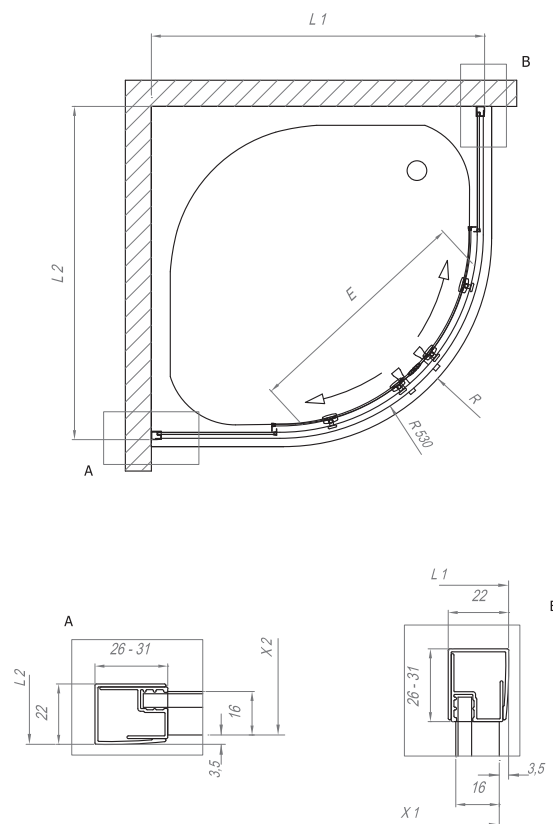

Lavolta R, Moonwalk R, Macarena, Drop R, Malur, Dixie, Evelin Tray R, Ontex.

Eco Quat			L1	L2	X1	X2			E	
TKP 90			875 - 880	875 - 880	872 - 877	872 - 877	550	1850	570	
TKP 80			775 - 780	775 - 780	772 - 777	772 - 777	550	1850	450	



Polaris

POLARIS

	<p>8 mm kaljeno prozorno steklo 8 mm transparent tempered glass 8 mm kaljeno prozirno staklo 8 mm prozirno kaljeno staklo</p>	
8 mm		
	<p>Silver Brill profili (visokopolirana srebrna galvanska prevleka) Silver Brill Studs (high gloss-polished silver galvanised coating) Silver Brill profili (visokopolirana srebrna galvanska prevleka) Silver Brill profili (visokopolirani srebrni galvanski premaz)</p>	
1400 mm		
	<p>BLACK (črni) profili, prašno lakiranje BLACK profiles, powder coating BLACK (crni) profili, lakiranje prahom BLACK (crni) profili, suvo lakiranje</p>	
1400 mm		
	<p>opora za stabilnost stekla glass stabilization support potpora za stabilizacijo stakla oslonac za stabilizacijo stakla</p>	
	<p>Clean coat, zaščitni premaz Clean coat, protective coating Clean coat, zaščitni premaz Clean coat, zaščitni premaz</p>	

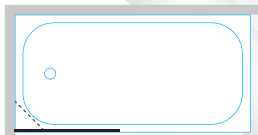

Polaris BS 80 UNI 1



Opora stekla za BS 80 UNI 1
Glass support for BS 80 UNI 1
Držač stakla za BS 80 UNI 1
Potpora stakla za BS 80 UNI 1

BS 80 UNI 1

- **Enodelni krilni zaslon za kopalne kade.** Možnost montaže levo ali desno. Zaslon je namenjen kopalnim kadem vseh dolžin.
- **One-piece screen for bathtubs fixed.** Left- and right-hand installation options. Suitable for all lengths of bathtubs.
- **Jednodijelni krilni paravan za kupaonske kade.** Mogućnost montaže lijevo i desno. Paravan je primjeren za kupaonske kade svih dužina.
- **Jednodielni tuš paravan za kadu.** Mogućnost montaže levo ili desno. Tuš paravan je namenjen za kade svih dužina.

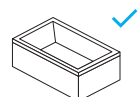
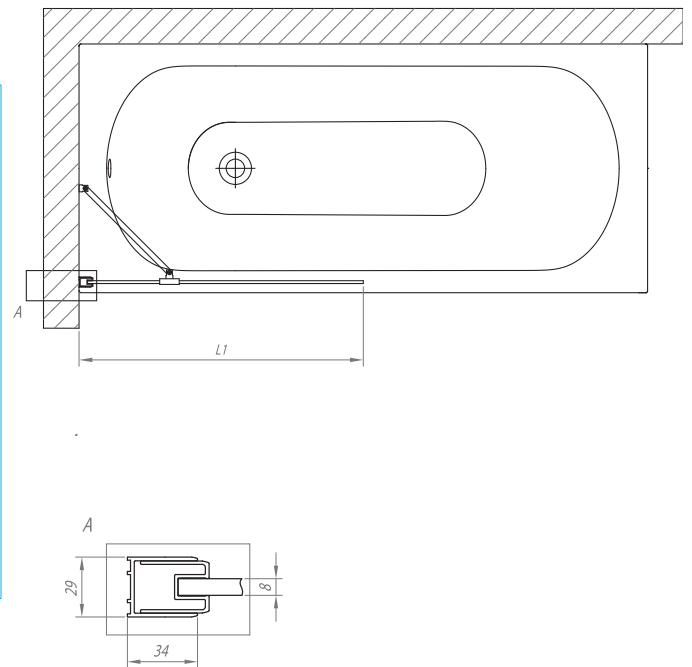



220



Andromeda

ANDROMEDA

 8/6 mm	<p>8/6 mm prozorno steklo 8/6 mm transparent tempered glass 8/6 mm kaljeno prozorno staklo 8/6 mm prozirno kaljeno staklo</p>	 
 1400 mm	<p>Silver Brill profili (visokopolirana srebrna galvanska prevleka) Silver Brill Studs (high gloss-polished silver galvanised coating) Silver Brill profili (visokopolirana srebrna galvanska prevlaka) Silver Brill profili (visokopolirani srebrni galvanski premaz)</p>	 
 1400 mm	<p>BLACK (črni) profili, prašno lakiranje BLACK profiles, powder coating BLACK (crni) profili, lakiranje prahom BLACK (crni) profili, suvo lakiranje</p>	 
 1400 mm	<p>opora za stabilnost stekla glass stabilization support potpora za stabilizacijo stakla oslonac za stabilizacijo stakla</p>	
	<p>Clean coat, zaščitni premaz Clean coat, protective coating Clean coat, zaštitni premaz Clean coat, zaštitni premaz</p>	

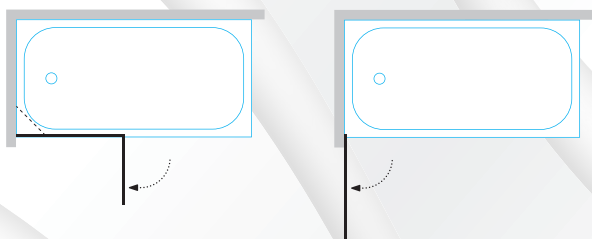

Andromeda BS 120 UNI 1-2P

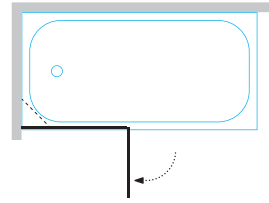

BS 120 UNI 1-2P

- Dvodelni krilni zaslon za kopalne kade na obračalnem profilu. Možnost montaže levo ali desno. Zaslon je namenjen ravnim kopalnim kadem vseh dolžin.
- Two-piece screen for bathtubs fixed on outer profile hinges. Left- and right-hand installation options. Suitable for all lengths of bathtubs.
- Dvodijelni krilni paravan za kupaonske kade na profilu na okretanje. Mogućnost montaže lijevo i desno. Paravan je primjeren za ravne kupaonske kade svih dužina.
- Dvodelni tuš paravan na profilu koji se okreće. Mogućnost montaže levo ili desno. Tuš paravan je namenjen za ravne kade svih dužina.

Opora stekla za BS 120 UNI 1-2P
Glass support for BS 120 UNI 1-2P
Držac stakla za BS 120 UNI 1-2P
Potpora stakla za BS 120 UNI 1-2P

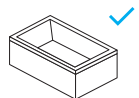
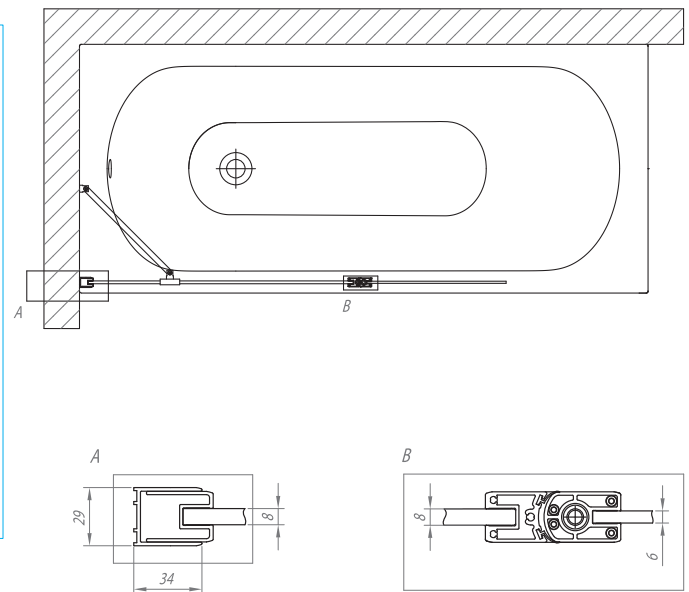

Andromeda BS 80 UNI 1-1P

223

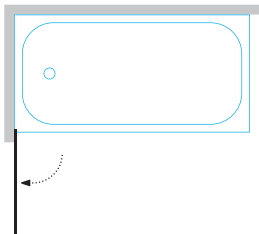

BS 80 UNI 1-1P

- Enodelni krilni zaslon za kopalne kade na obračalnem profilu. Možnost montaže levo ali desno. Zaslon je namenjen ravnim kopalnim kadem vseh dolžin.
- One-piece screen for bathtubs fixed on outer profile hinges. Left- and right-hand installation options. Suitable for all lengths of bathtubs.
- Jednodijelni krilni paravan za kupaonske kade na profilu na okretanje. Mogućnost montaže lijevo i desno. Paravan je primjeren za ravne kupaonske kade svih dužina.
- Jednodielni tuš paravan na profilu koji se okreće. Mogućnost montaže levo ili desno. Tuš paravan je namenjen za ravne kade svih dužina.

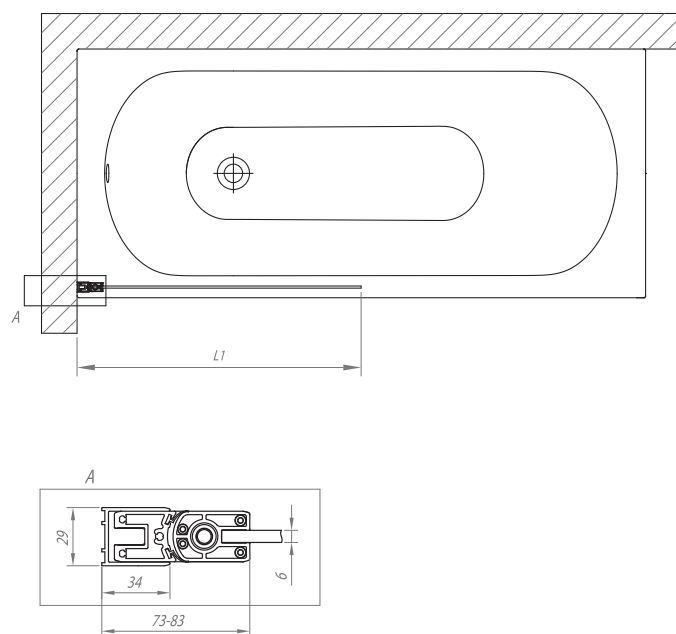
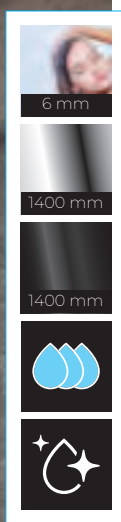
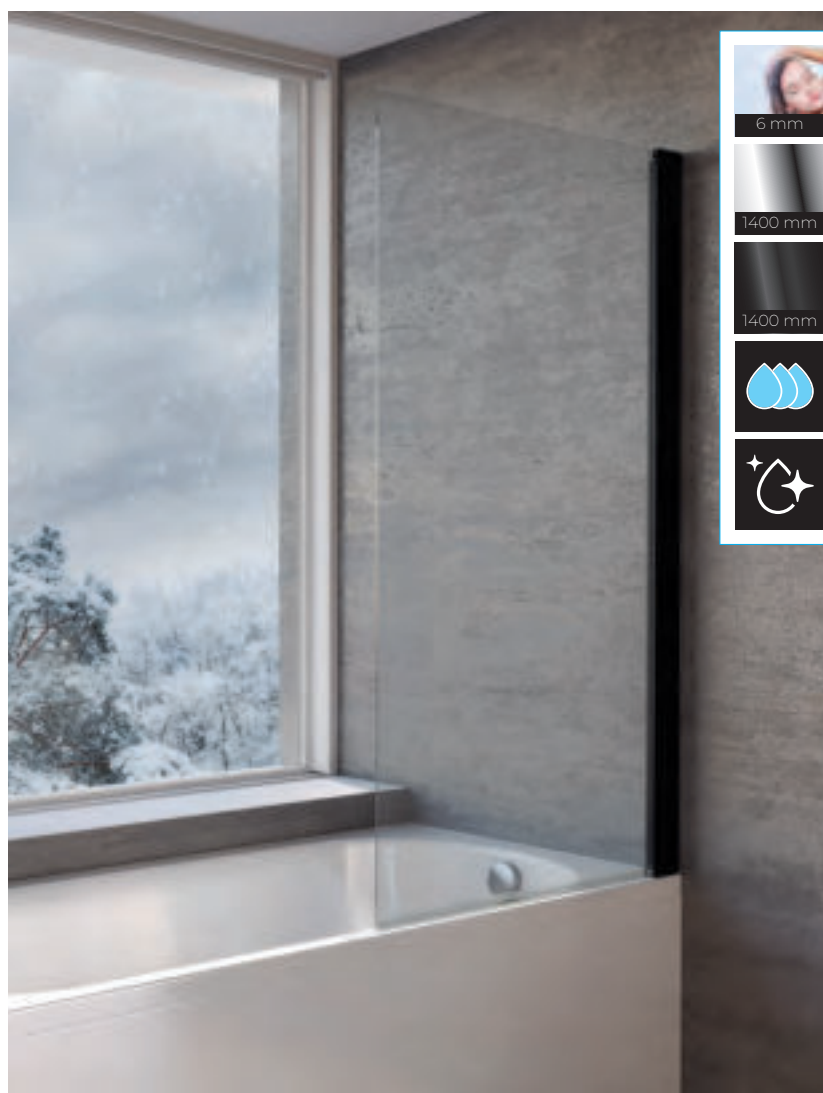

Andromeda BS 80 UNI 1-1P

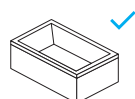

Andromeda
BS 80 UNI 1-2P



L1
800

L2
800

X1
800

X2
800

1400



224









6 mm

1400 mm

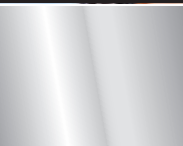
Sole

SOLE

	<p>6 mm kaljeno prozorno steklo 6 mm transparent tempered glass 6 mm kaljeno prozirno staklo 6 mm prozirno kaljeno staklo</p>	 
6 mm		
	<p>Silver profili (srebrna galvanska prevleka) Silver Studs (silver galvanised coating) Silver profili (srebrna galvanska prevlaka) Silver profili (srebrni galvanski premaz)</p>	 
1400 mm		
	<p>Kromirana opora (10x15, dolžina=52cm) za stabilizacijo stekla za: TP 102, TP 104 Chromium-plated (10x15, length=52cm) support to stabilize glass for: TP 102, TP 104 Kromirana podrška (10x15, dužina=52cm) za stabilizacijo stakla za: TP 102, TP 104 Hromirana podrška (10x15, dužina=52cm) za stabilizacijo stakla za: TP 102, TP 104</p>	

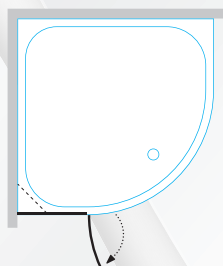
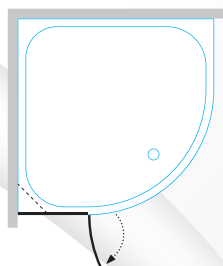

Sole TP 102 UNI

226

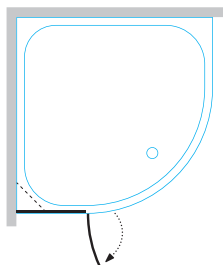

Opora stekla za TP (tp 102,104)
Glass support for TP (tp 102,104)
Držac stakla za TP (tp 102,104)
Potpora stakla za TP (tp 102,104)

TP 102 UNI

• Dvodelni krilni zaslon za kopalne kadi na obračalnem zidnem profilu.

Prvo krilo na tečajjih, preklopno na zunanjo stran, obe krili zložljivi na notranjo ali zunanjo stran.

• Two-piece screen for bathtubs fixed on outer wall profile hinges.

One of the hinged wings can be opened outwards, while both folded together can be opened to either side.

• Dvodijelni krilni paravan za kupaonske kade na zidnom profilu na okretanje.

Prvo krilo je na šarkama koje se preklapaju na vanjsku stranu. Oba krila se mogu sklopiti na unutarnju ili vanjsku stranu.

• Dvodelni tuš paravan na zidnom profilu koji se okreće.

Prvo krilo je na šarkama, drugo se preklapa na spoljašnju, a oba su sklopiva na unutrašnju ili spoljašnju stranu.

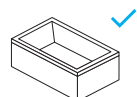
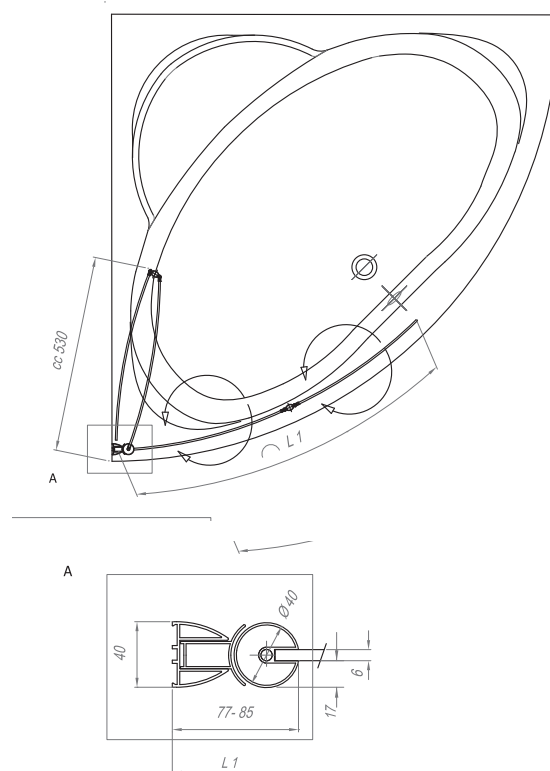

Sole TP 104 UNI

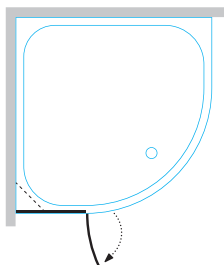

TP 104 UNI

- Dvodelni krilni zaslon za kopalne kade na obračalnem zidnem profilu.

Prvo krilo na tečajjih, preklopno na zunanjo stran, obe krili zložljivi na notranjo ali zunanjo stran.

- Two-piece screen for bathtubs fixed on outer wall profile hinges.

One of the hinged wings can be opened outwards, while both folded together can be opened to either side.

- Dvodielni krilni paravan za kupaonske kade na zidnom profilu na okretanje.

Prvo krilo je na šarkama koje se preklapaju na vanjsku stranu. Oba krila se mogu sklopiti na unutarnju ili vanjsku stranu.

- Dvodielni tuš paravan na zidnom profilu koji se okreće.

Prvo krilo je na šarkama, drugo se preklapa na spoljašnju, a oba su sklopiva na unutrašnju ili spoljašnju stranu.



Opora stekla za TP (tp 102,104)
Glass support for TP (tp 102,104)
Držac stakla za TP (tp 102,104)
Potpora stakla za TP (tp 102,104)

227

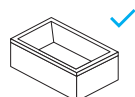
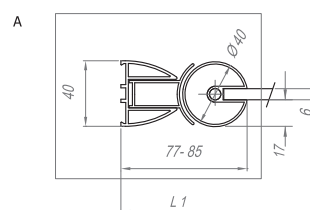
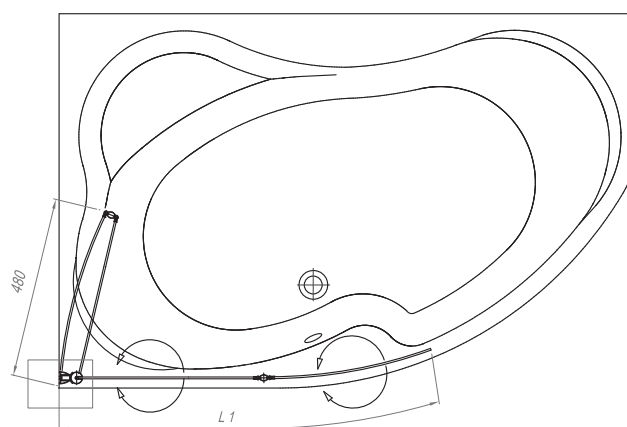

Sole TP 104

Sole

TP 104

L1
1040

L2

X1

X2

E
1400





1400 mm

2 mm

Quat

QUAT

 5 mm	<p>5 mm kaljeno prozorno steklo 5 mm transparent tempered glass 5 mm kaljeno prozirno staklo 5 mm prozirno kaljeno staklo</p>	 
 2 mm	<p>2 mm polistirensko steklo Quat 2 mm Quat polystyrene glass 2 mm polistiren staklo Quat 2 mm polistirensko staklo Quat</p>	 
 1400 mm	<p>Silver profili (srebrna galvanska prevleka) Silver Studs (silver galvanised coating) Silver profili (srebrna galvanska prevlaka) Silver profili (srebrni galvanski premaz)</p>	 
 1400 mm	<p>Beli profili (prašno lakiranje) White Studs (powder coating) Beli profili (lakiranje raspršivanjem) Fehér profilok (porlakkozás)</p>	 

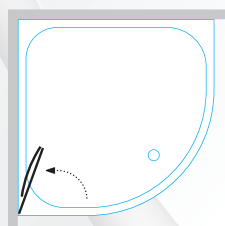
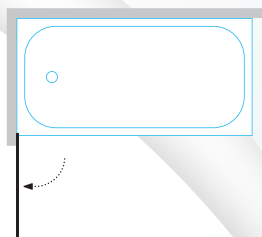

Quat TP 80 UNI

230

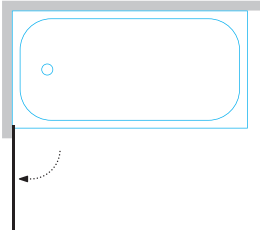

TP 80 UNI

- Enodelni krilni zaslon za kopalne kade na obračalnem zidnem profilu. Možnost montaže levo ali desno. Zaslon je namenjen kopalnim kadem vseh dolžin.
- One-piece screen for bathtubs fixed on outer wall profile hinges. Left- and right-hand installation options. Suitable for all lengths of bathtubs.
- Jednodijelni krilni paravan za kupaonske kade na zidnem profilu na okretanje. Mogućnost montaže lijevo i desno. Paravan je primjeren za kupaonske kade svih dužina.
- Jednodielni tuš paravan na zidnom profilu koji se okreće. Mogućnost montaže levo ili desno. Tuš paravan je namenjen za kade svih dužina.

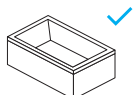
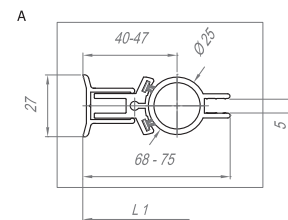
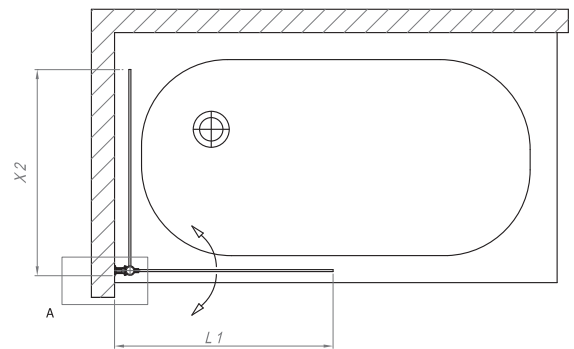
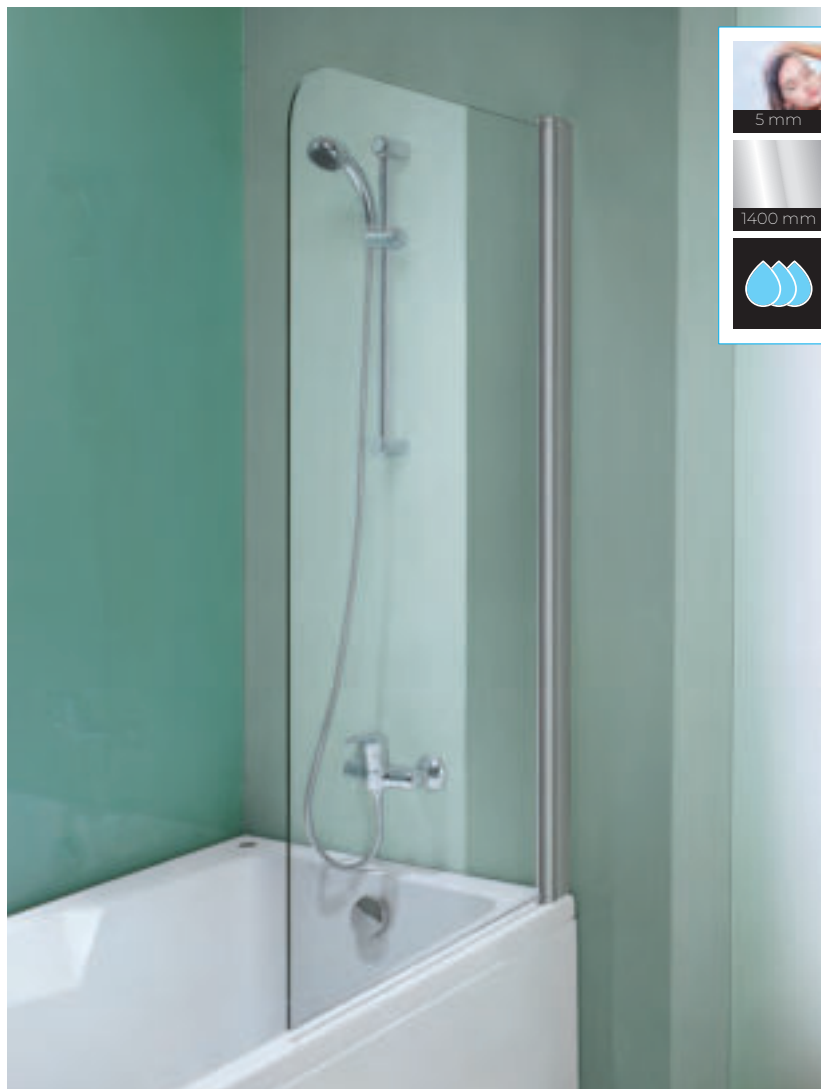

Quat TP 80 UNI

Quat TP 105, 108 UNI

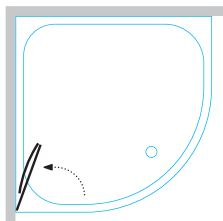

TP 105, 108 UNI

- Zložljiv dvodelni krilni zaslon za kotne kopalne kadi. Možnost montaže levo ali desno.
- One-piece screen for bathtubs fixed on outer wall profile hinges. Left- and right-hand installation options.
- Sklopivi dvodijelni krilni paravan za kutne kupaonske kade. . Mogućnost montaže lijevo ili desno.
- Sklopivi dvodelni tuš paravan za ugaone kade. Mogućnost montaže levo ili desno.

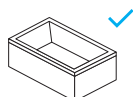
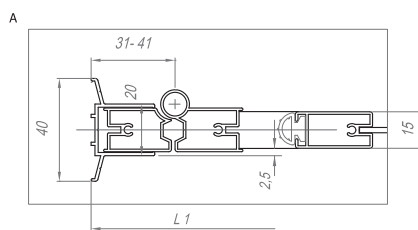
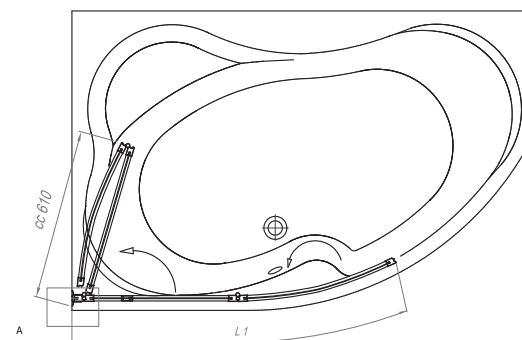
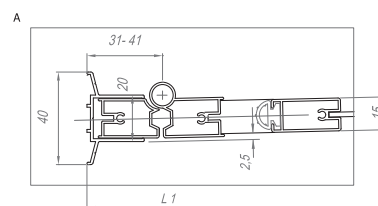
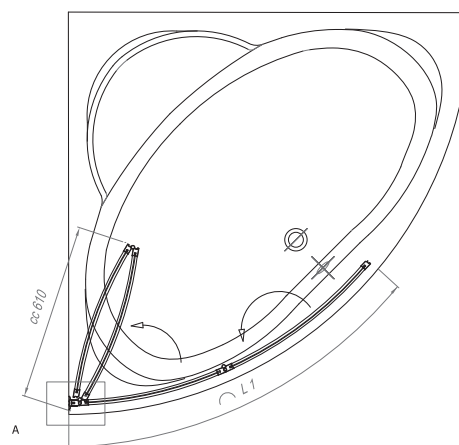

Quat			L1	L2	X1	X2		E	
TP 105 UNI			1050				1400		
TP 108 UNI			1080				1400		



Dodatni profili pri tuš kabinah

Additional profiles for shower enclosures

Dodatni profili za tuš kabine

Dodatni profili kod tuš kabina



Imam nestandardne dimenzije kopalnice, kaj pa zdaj?
The dimensions of my bathroom are non-standard. What now?
Imam nestandardne dimenzije kupaonice, što sada?
Imam nestandardne dimenzije kupatila, šta da radim?

Za primere, ko prostor na razpolago za vgradnjo tuš kabin ni standardnih dimenzij, smo razvili dodatne kompenzacijske profile, s katerimi lahko prilagodimo standardne izdelke na željeno mero. Na naslednjih straneh lahko preverite, kateri izdelki ponujajo to možnost.

For the situations where the space available for the installation of a shower cabin/enclosure is of non-standard size, we have designed additional compensation studs allowing adjusting standard products to the desired dimensions. Check the following pages for products offering this option.

Za slučajeve kada prostor na raspolaganje za ugradnju tuš kabina nije standardnih dimenzija razvili smo dodatne kompenzacijske profile s kojima možemo prilagoditi standardne proizvode prema željenoj mjeri. Na sljedećim stranicama možete provjeriti proizvodi pružaju tu mogućnost.

Za slučajeve, kad prostor za ugradnju tuš kabina nije standardnih dimenzija, razvili smo dodatne kompenzacione profile pomoću kojih možemo da prilagodimo standardne proizvode na željenu meru. Na sledećim stranicama možete da proverite koji proizvodi pružaju tu mogućnost.

Primer uporabe dodatnega profila
Example of using an additional profile
Primjer uporabe dodatnoga profila
Primer korišćenja dodatnog profila

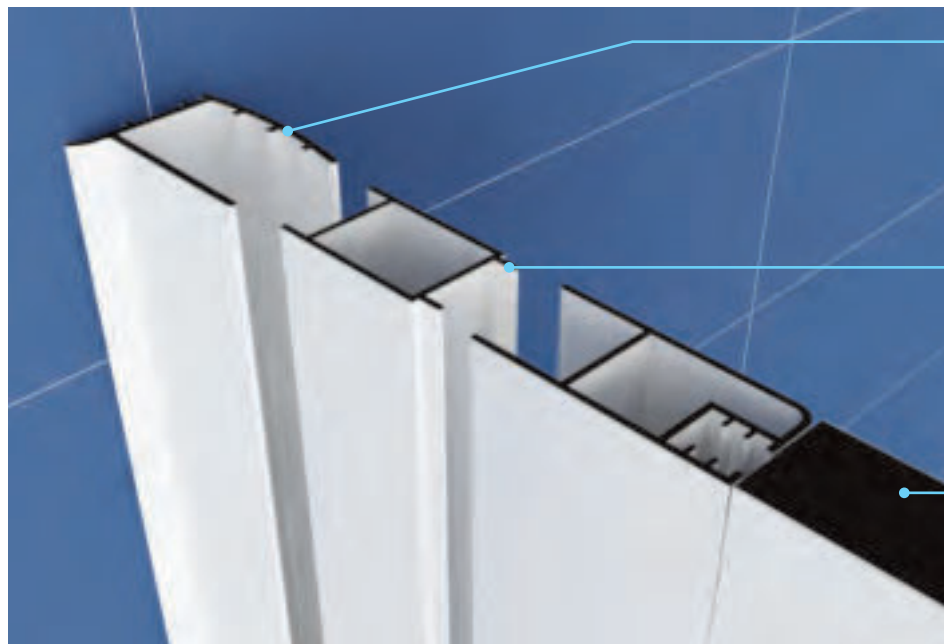

zidni profil
wall profile
zidni profil
zidni profil

dodatni kompenzacijski profil
additional compensation profile
dodatni kompenzacijski profil
dodatni kompenzacioni profil

tuš vrata
shower enclosures
tuš vrata
tuš vrata



Tuš kabine posebnih dimenzij

Shower cabins with special dimensions

Tuš kabine posebnih dimenzija

Tuš kabine specijalnih dimenzija

233



Kaj pa če v rednem programu ni rešitve za mojo tuš kabino?
 What if I don't find a solution for my shower enclosure in your regular programme?
 A što ako u redovnom programu nema rešenja za moju tuš kabinu?
 Šta ako u redovnom programu nema rešenja za moju tuš kabinu?

V primeru, da vam naše standardne rešitve tuš kabin ne pridejo prav, vam lahko izdelamo rešitev po meri.
 Za več informacij o tuš kabinah posebnih dimenzij obiščite spletno stran www.kolpa.si.

In case our standard solutions of shower cabins/enclosures fail to meet your requirements, we can design a tailor-made solution for you.
 For more information on non-standard shower cabins/enclosures, visit our www.kolpa.si website.

U slučaju da vam naša standardna rešenja tuš kabina ne odgovaraju, možemo vam izraditi rešenje po mjeri.
 Za više informacija o tuš kabinama posebnih dimenzija posjetite internetsku stranicu www.kolpa.si.

U slučaju da vam naša standardna rešenja tuš kabina ne odgovaraju, možemo vam izraditi rešenje po mjeri.
 Za više informacija o tuš kabinama posebnih dimenzija posetite internet stranu www.kolpa.si.



Možnost prilagoditve višine
 Height adjustment option
 Mogućnost prilagodbe visine
 Mogućnost prilagođavanja visine



Možnost prilagoditve širine
 Width adjustment option
 Mogućnost prilagodbe širine
 Mogućnost prilagođavanja širine



Možnost prilaganja naklonskega kota
 Angle adjustment option
 Mogućnost prilagođavanja nagibnog kuta
 Mogućnost prilagođavanja nagiba



Možnost prilaganja oblike
 Shape adjustment option
 Mogućnost prilagođavanja oblika
 Mogućnost prilagođavanja oblika



Možnosti izbire barve profila
 Stud colour options
 Mogućnost odabira boje profila
 Mogućnost izbora boje profila



Info

Za zelo zahtevne primere tuš kabin, ki jih ne najdete v tej ponudbi, lahko za kupca poiščemo individualno rešitev.
 When no suitable solution for complex shower cabins can be found in this catalogue, we'll be happy to fix an individual solution for you.
 Za vrlo složene slučajeve tuš kabina koje niste pronašli u ovoj ponudi, za kupca možemo pronaći i individualno rešenje.
 Za izuzetno komplikovane slučajeve tuš kabina, ako ih niste našli u ovoj ponudi, možemo za kupca potražiti individualno rešenje.



RE WALL-Univerzalna Kerrock stena

RE WALL-Universal Kerrock wall
RE WALL-Univerzalni Kerrock zid
RE WALL-Univerzalni Kerrock zid

Orodje, priprava in meritve
Tools, preparation and measurements
Alat, priprema i mjerenje
Alat, priprema i merenje



Vrtanje izvrtine za pipo
in postavitev leve stene

Drilling the tap hole and
setting the left wall

Bušenje rupe za slavinu i
postavljanje lijeve stijene

Bušenje rupe za slavinu i
postavljanje levog stuba

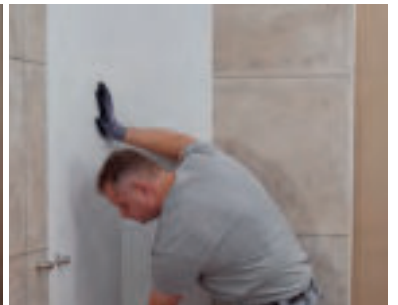
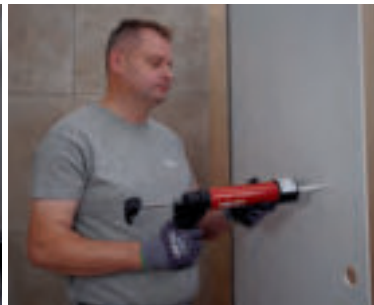

Postavitev desne stene
Right wall layout
Postavljanje desne stijene
Postavljanje desnog stuba

Montaža tuš kabine z dodatno oporo
Installation of shower enclosure with additional support
Montaža tuš kabine s dodatnom potporom
Montaža tuš-kabine sa dodatnim osloncem

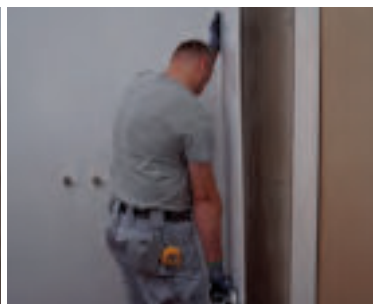



RE WALL-Univerzalna Kerrock stena

RE WALL-Universal Kerrock wall
RE WALL-Univerzalni Kerrock zid
RE WALL-Univerzalni Kerrock zid

235



Re-Wall
80x80, 90x90, 100x100,
120x80, 120x90,
140x80, 140x90,
160x80, 160x90
H = 2200mm

kerrock[®]
BY KROFA



109 - White



9252 - Andesite



Tri-delni element-demontažno
Three-piece element-disassembly
Trodeljni element-uklonjivo
Trodelni elemenat, može se demontirati



Info